

IP CAMERA SERIES

OPERATION GUIDE

Please read instructions thoroughly before operation and retain it for future reference.

IMPORTANT SAFEGUARD



All lead-free products offered by the company comply with the requirements of the European law on the Restriction of Hazardous Substances (RoHS) directive, which means our manufacture processes and products are strictly "lead-free" and without the hazardous substances cited in the directive.



The crossed-out wheeled bin mark symbolizes that within the European Union the product must be collected separately at the product end-of-life. This applies to your product and any peripherals marked with this symbol. Do not dispose of these products as unsorted municipal waste. Contact your local dealer for procedures for recycling this equipment.



This is a class A product. In a domestic environment this product may cause radio interference in which case the user may be required to take adequate measures.

Federal Communications Commission Interference Statement

This equipment has been tested and found to comply with the limits for a Class A digital device, pursuant to Part 15 of the FCC Rules. These limits are designed to provide reasonable protection against harmful interference when the equipment is operated in a commercial environment. This equipment generates, uses, and can radiate radio frequency energy and, if not installed and used in accordance with the instruction manual, may cause harmful interference to radio communications. Operation of this equipment in a residential area is likely to cause harmful interference in which case the user will be required to correct the interference at his own expense.

This device complies with Part 15 of the FCC Rules. Operation is subject to the following two conditions:

- (1) This device must not cause harmful interference, and
- (2) This device must accept any interference received, including interference that may cause undesired operation.

Trademark Acknowledgements

iPad® & iPhone® are the registered trademarks of Apple Inc.

Android™ is a trademark of Google Inc. Use of this trademark is subject to Google Permissions.

Microsoft®, Windows® & Internet Explorer® are registered trademarks of Microsoft Corporation in the United States and/or other countries.

Disclaimer

We reserve the right to revise or remove any content in this manual at any time. We do not warrant or assume any legal liability or responsibility for the accuracy, completeness, or usefulness of this manual. The content of this manual is subject to change without notice.

This product doesn't have a standby / off mode.

MPEG4 Licensing

THIS PRODUCT IS LICENSED UNDER THE MPEG4 VISUAL PATENT PORTFOLIO LICENSE FOR THE PERSONAL AND NON-COMMERCIAL USE OF A CONSUMER FOR (i) ENCODING VIDEO IN COMPLIANCE WITH THE MPEG4 VISUAL STANDARD ("MPEG-4 VIDEO") AND/OR (ii) DECODING MPEG4 VIDEO THAT WAS ENCODED BY A CONSUMER ENGAGED IN A PERSONAL AND NON-COMMERCIAL ACTIVITY AND/OR WAS OBTAINED FROM A VIDEO PROVIDER LICENSED BY MPEG LA TO PROVIDE MPEG4 VIDEO. NO LICENSE IS GRANTED OR SHALL BE IMPLIED FOR ANY OTHER USE. ADDITIONAL INFORMATION INCLUDING THAT RELATING TO PROMOTIONAL INTERNAL AND COMMERCIAL USES AND LICENSING MAY BE OBTAINED FROM MPEG LA, LLC. SEE [HTTP://WWW.MPEGLA.COM](http://www.mpegla.com).

GPL Licensing



This product contains codes which are developed by Third-Party-Companies and which are subject to the GNU General Public License ("GPL") or the GNU Lesser Public License ("LGPL").

The GPL Code used in this product is released without warranty and is subject to the copyright of the corresponding author.

Further source codes which are subject to the GPL-licenses are available upon request.

We are pleased to provide our modifications to the Linux Kernel, as well as a few new commands, and some tools to get you into the code. The codes are provided on the FTP site, and please download them from the following site or you can refer to your distributor:

Model 1, 2, 3 & 4: <http://download.dvrtw.com.tw/GPL/IPCAM/F-Series/linux.tar.gz>

Model 5: <http://download.dvrtw.com.tw/GPL/IPCAM/A-Series/linux.tar.gz>

Model 6 & 7: <http://download.dvrtw.com.tw/GPL/IPCAM/S-Series/linux.tar.gz>

TABLE OF CONTENTS



1. OVERVIEW.....	1
1.1 Product Features.....	1
1.2 Package Content.....	1
1.3 Cable Overview.....	2
1.5 External Alarm Connection.....	2
2. CAMERA ACCESS WITH INTERNET EXPLORER.....	4
2.1 Camera Login.....	4
2.2 Control Panel Overview.....	4
2.3 Digital PTZ (DPTZ) Operations.....	6
2.4 Event Record Search & Playback.....	8
3. CAMERA CONFIGURATIONS.....	9
3.1 System configuration menu.....	9
3.2 Network.....	11
3.2.1 Network.....	11
3.2.2 QoS.....	11
3.2.3 DDNS.....	11
3.2.4 SNTP.....	11
3.2.5 FTP.....	12
3.2.6 MAIL.....	12
3.2.7 SMS.....	13
3.2.8 Filter.....	14
3.2.9 UPnP / Bonjour.....	14
3.2.10 RTP.....	15
3.3 Camera.....	17
3.3.1 Camera.....	17
3.3.2 Video.....	17
3.3.3 Color.....	18
3.3.4 Advanced.....	18
3.3.5 Privacy Mask (For selected models only).....	19
3.4 Record.....	20
3.4.1 Record.....	20
3.4.2 Record Timer.....	20
3.5 Storage.....	20
3.5.1 Memory.....	20
3.6 Trigger.....	21
3.6.1 Trigger.....	21
3.7 General.....	22
3.7.1 General.....	22
3.7.2 Time.....	22
3.7.3 Server Log.....	23
3.7.4 Online.....	23
3.7.5 Account.....	24
3.7.6 Google Maps.....	24
3.7.7 Maintenance.....	25
APPENDIX 1 PRODUCT SPECIFICATIONS.....	27
APPENDIX 2 BIT RATE TABLE FOR REFERENCE.....	36
APPENDIX 3 POE CONNECTION.....	38
APPENDIX 4 API ID APPLICATION FOR SMS MESSAGING.....	39
APPENDIX 5 Q&A.....	41
APPENDIX 6 RECORDING TIME TABLE.....	42
APPENDIX 7 MICRO SD CARD COMPATIBLE LIST.....	43

1. OVERVIEW



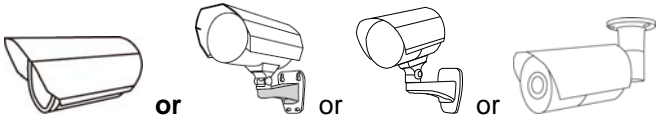

1.1 Product Features

- Easy network setup with your iPhone / iPad
- 1.3 / 2 Megapixel solution with HDTV 720p quality, allowing users to notice minor details more easily
- Solid light series featuring better overexposure prevention (Advanced Smart Light Control)
- ONVIF standard supported to simplify system integration
- POE (Power-over-Ethernet) support to eliminate the use of power cables and reduce installation costs
- External alarm I/O device connection
- IR LEDs built-in for night surveillance
- *(For selected model only)* Equipped with a vari-focal lens of f2.8 ~ 12mm, suitable for various monitoring environments.
- *(For selected model only)* WDR to increase image recognizability in overexposure and dark areas.
- *(For selected model only)* Zoom lens of f6.0 ~ 60mm with 10x optical zoom, 10x digital zoom and auto focus, suitable for various monitoring environments.
- *(For selected model only)* Micro SD card support for video storage.
- *(For selected model only)* Built-in heater which can operate at temperatures as low as -40°C.
- Remote Surveillance
 - Full compatibility on iPhone & iPad, and Internet Explorer® on Windows® operating system

1.2 Package Content

	
Camera	Quick guide

For selected models only:

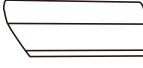
					
Screws	Wall Plugs	Wrenches	Bracket	Desiccant	Sun Shield

1.3 Cable Overview

Type A:

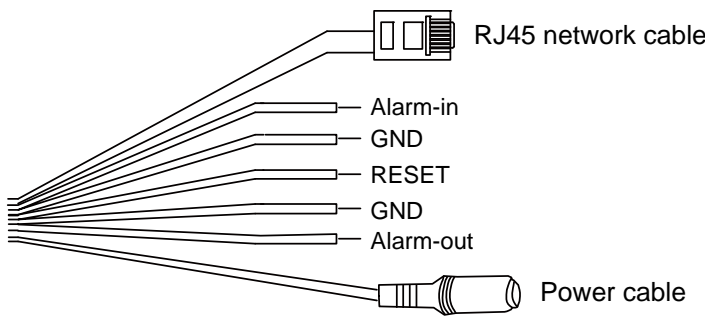

Type B:

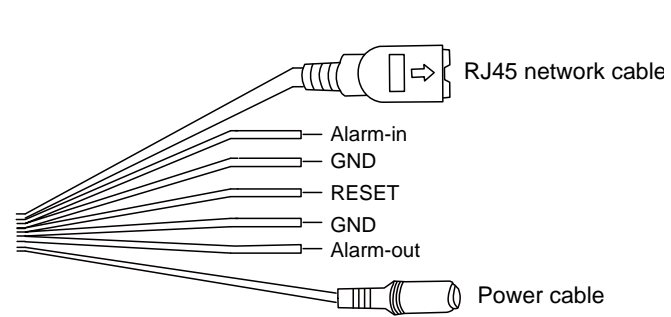

Cable	Description
Power cable	Connect to DC12V power supply. Note: The power adapter is optional.
RJ45 network cable	Connect it to the supplied RJ45 cable extender adapter for cable extension, and prepare another RJ45 network cable with suitable length for your connection.
GND	Ground wire, used for reset default or external device connection.
Alarm-in	Reserved for connecting to an external alarm device. For details, please refer the user manual of your alarm device.
Alarm-out	Reserved for connecting to an external alarm device. For details, please refer the user manual of your alarm device.
RESET	Remove the insulating coating of this wire, and twist it with a ground wire together to reset default. This will reset all parameters, including the IP address to factory default settings. Note: Disconnect power before twisting these two wires together, and connect to power again for reset default.

1.5 External Alarm Connection

This camera supports external I/O device connection for easy connection.

Below shows you how to connect an external device to this camera.

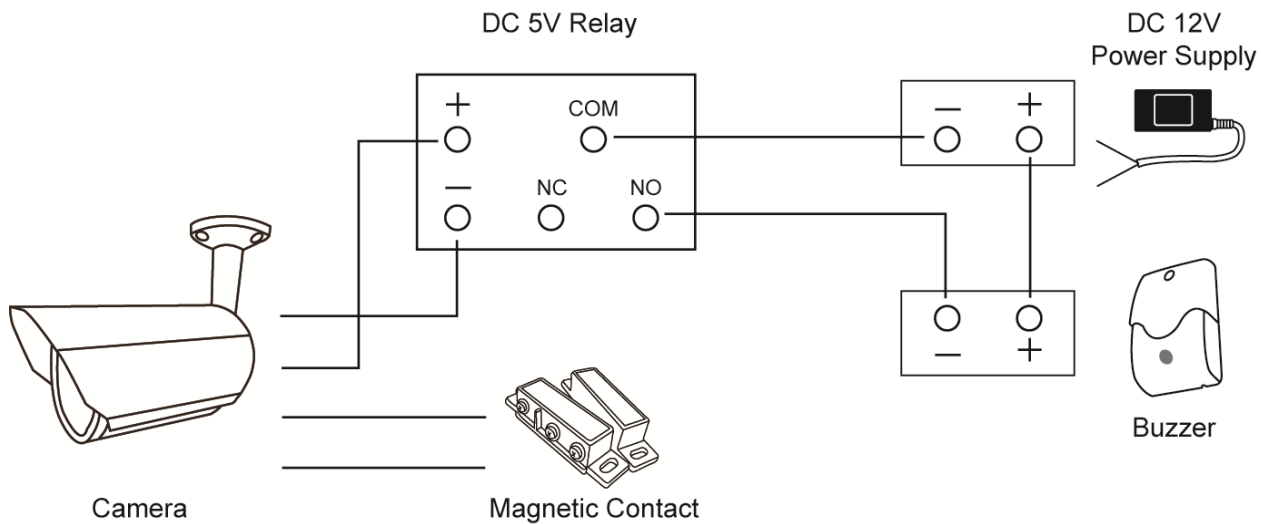

1.5 Insert a Micro SD card (For selected models only)

For local video recording, a micro SD card slot can be found on the camera. The camera doesn't support hot-swapping. Please insert or remove the micro SD card with power disconnected. The data originally saved in the micro SD card (if any) will be removed after inserting it to the camera.

Note: Only selected models are equipped with a micro SD card slot for local video recording.

Please follow the directions in the below graphic to insert Micro SD card properly:

Type A:

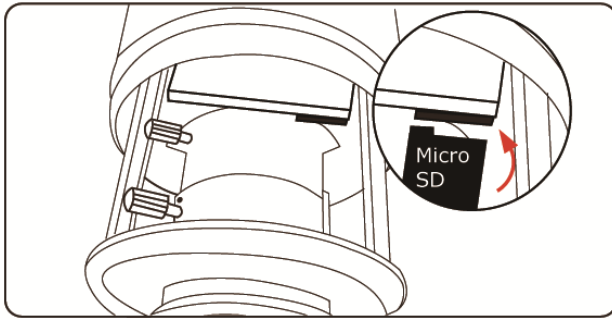

Type B:

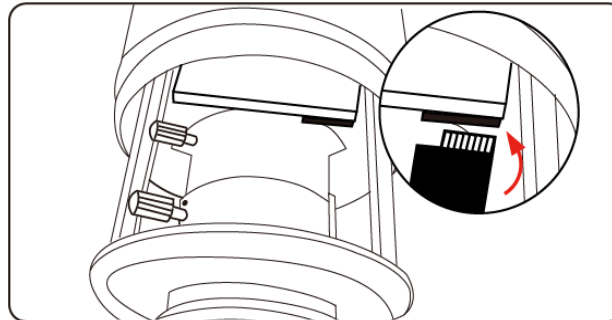

Note: It's recommended to use tweezers for inserting / removing Micro SD card.

2. CAMERA ACCESS WITH INTERNET EXPLORER

This network camera can be accessed via Microsoft® Internet Explorer® and iPhone / iPad / Android mobile devices with our self-developed program “EagleEyes” installed depending on different using situations.

Note: For details about accessing network cameras via iPhone / iPad / Android mobile devices, please refer to <http://www.eagleeyesccv.com>.

Before using the camera, make sure you have configured the network settings, and the network connection is fine.

For network configurations, please refer to:

- “ADVANCED NETWORK SETUP” downloadable from www.surveillance-download.com/user/m359a.swf if your network environment is not wireless.

2.1 Camera Login

Step1: Open your web browser, and key in <http://ipaddress:portnum> in the URL address box.

For example, for the IP address 60.121.46.236 and port No. 888, please key in “<http://60.121.46.236:888>” into the URL address box, and press “Enter”.

Step2: In the login page, key in the user name and password, and enter the security code from the image below if any. Then, click “LOGIN”.

Step3: The wizard is then started.

- To skip the wizard and directly access the camera live view, click “Close”.
- To directly access the camera live view without starting the wizard for the login next time, check “Do not start wizard at login”.

Note: If you're prompted to install “VLC player”, “Software” and “H264 Streaming Viewer”, please agree to proceed the installation.

Step5: When the login is successful, the live view is shown.

2.2 Control Panel Overview

Note: The buttons available depend on the user level used to log in.



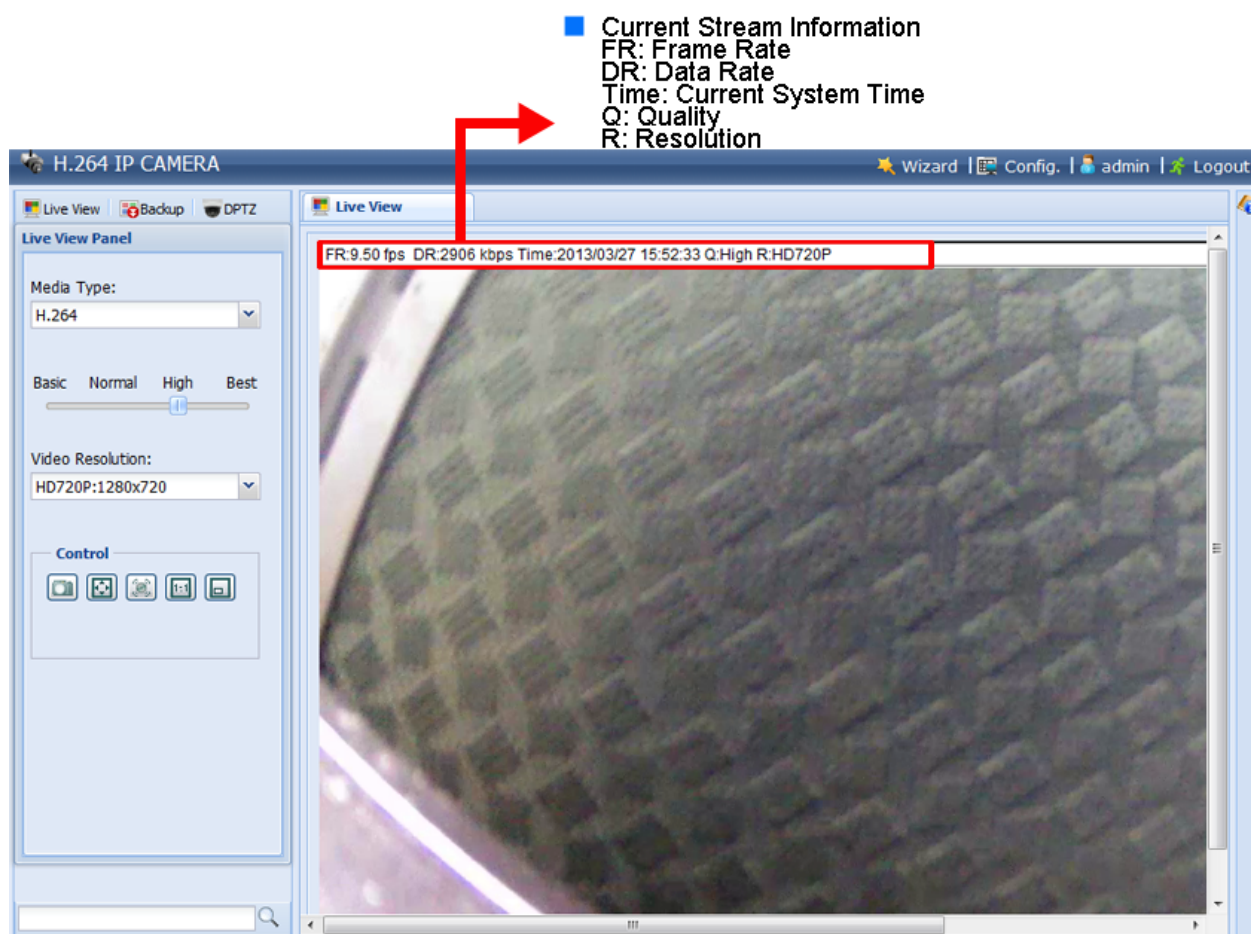



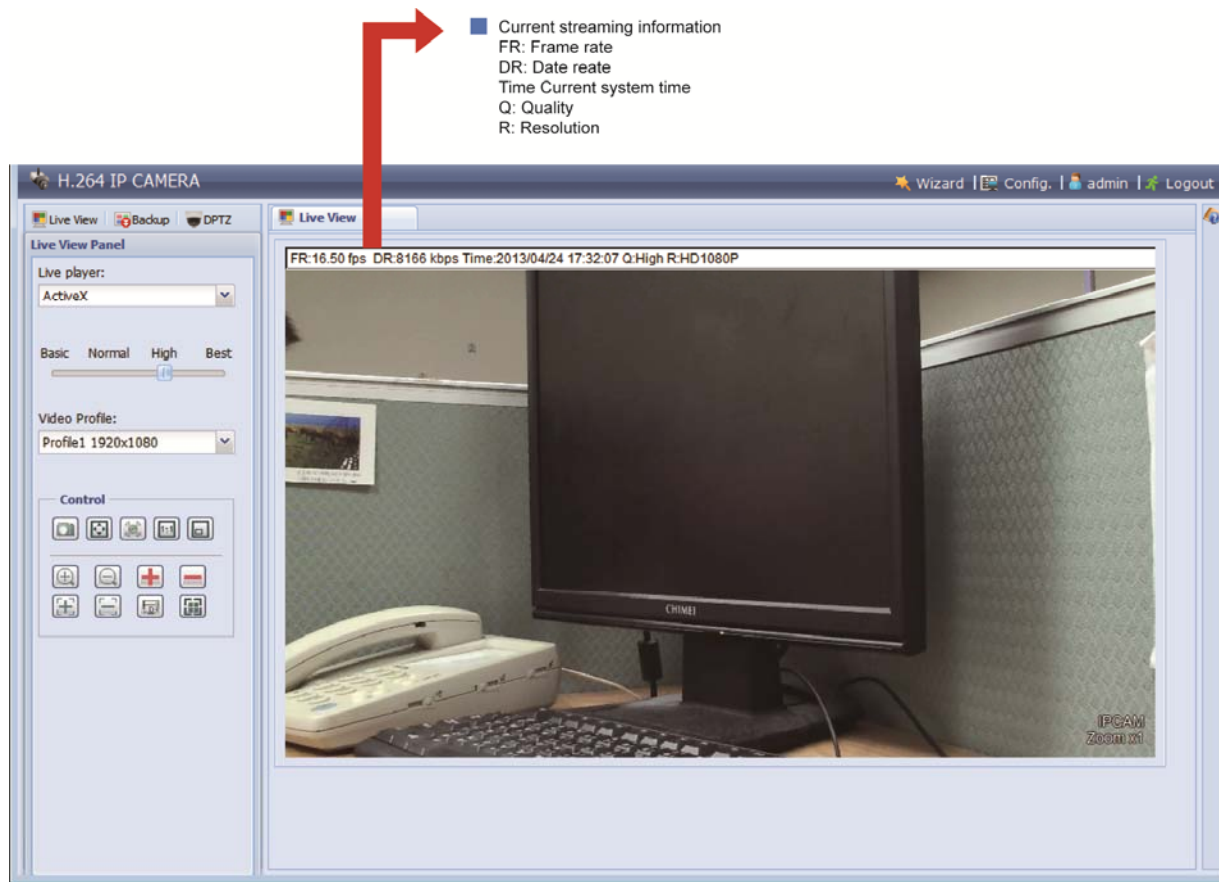





➤ Type A:



➤ Type B:



Function	Icon	User Level	Description		
Live		Supervisor / Power User / Normal User / Guest	Switch to the live view page.		
DPTZ		Supervisor / Power User / Normal User	Switch to the DPTZ configuration page. For details, please refer to "2.3 Digital PTZ (DPTZ) Operations" at page 6.		
Backup		Supervisor / Power User	Enter the event record list for video playback. For details, please refer to "2.4 Event Record Search & Playback" at page 8.		
Config.		Supervisor / Power User	Switch to the system configuration page, and the functions available for "Supervisor" and "Power User" are different. For details, please refer to "3.1 System configuration menu" at page 9.		
Media Type*	--	Supervisor / Power User / Normal User / Guest	Select the image player from the drop-down list: <ul style="list-style-type: none"> ■ H.264 / MPEG-4 / Motion JPEG ■ QuickTime QuickTime is Apple Inc.'s multimedia software. You need to have QuickTime installed in your operating system before selecting "QuickTime". When it is selected, you will be promoted to enter the user name and password to access the camera. ■ VLC 		
Live player*	--	Supervisor / Power User / Normal User / Guest	Select the image player from the drop-down list: <ul style="list-style-type: none"> ■ ActiveX ■ QuickTime QuickTime is Apple Inc.'s multimedia software. You need to have QuickTime installed in your operating system before selecting "QuickTime". When it is selected, you will be promoted to enter the user name and password to access the camera. ■ VLC 		
Quality	--	Supervisor / Power User / Normal User	Click & drag the slider to select the video quality: BASIC / NORMAL / HIGH / BEST.		
Video Resolution	--	Supervisor / Power User / Normal User	Select the image resolution from the drop list: <table border="0" style="width: 100%;"> <tr> <td style="vertical-align: top;"> <u>2 megapixel model</u> <ul style="list-style-type: none"> ■ HD1080P (1920 x 1080) ■ HD720P (1280 x 720) ■ VGA (640 x 480) or D1 (720 x 480) ■ QVGA (320 x 240) or CIF (352 x 288) </td> <td style="vertical-align: top; padding-left: 20px;"> <u>1.3 megapixel model</u> <ul style="list-style-type: none"> ■ SXGA (1280 x 1024) ■ HD720P (1280 x 720) ■ VGA (640 x 480) ■ QVGA (320 x 240) </td> </tr> </table>	<u>2 megapixel model</u> <ul style="list-style-type: none"> ■ HD1080P (1920 x 1080) ■ HD720P (1280 x 720) ■ VGA (640 x 480) or D1 (720 x 480) ■ QVGA (320 x 240) or CIF (352 x 288) 	<u>1.3 megapixel model</u> <ul style="list-style-type: none"> ■ SXGA (1280 x 1024) ■ HD720P (1280 x 720) ■ VGA (640 x 480) ■ QVGA (320 x 240)
<u>2 megapixel model</u> <ul style="list-style-type: none"> ■ HD1080P (1920 x 1080) ■ HD720P (1280 x 720) ■ VGA (640 x 480) or D1 (720 x 480) ■ QVGA (320 x 240) or CIF (352 x 288) 	<u>1.3 megapixel model</u> <ul style="list-style-type: none"> ■ SXGA (1280 x 1024) ■ HD720P (1280 x 720) ■ VGA (640 x 480) ■ QVGA (320 x 240) 				
Video Profile*	--	Supervisor / Power User / Normal User	Select the pre-defined video set from the drop list. The video set could be configured in "Config" -> "Camera" -> "Video".		

Function	Icon	User Level	Description
Live View Size:		Supervisor / Power User / Normal User	
Full Screen			Click to display the image in full screen. To exit the full screen mode, press "Esc" on your keyboard. <i>This icon appears only when the selected resolution is HD1080P, SXGA or HD720P & VGA.</i>
Double size			The QVGA resolution is resized to fit into the current live view size. <i>This icon appears only when the selected resolution is QVGA.</i>
Normal Size			The current live view size is the same as the selected resolution. <i>This icon appear only when the selected resolution is SXGA or HD720P or HD1080P.</i>
Fit to screen			The selected resolution is resized to fit into the current live view size. <i>This icon appear only when the selected resolution is SXGA or HD720P or HD1080P.</i>
No Scale			Click and hold the movable square on the left bottom corner of the live view to move <i>This icon appear only when the selected resolution is SXGA or HD720P or HD1080P.</i>
Snapshot		Supervisor / Power User / Normal User	Click to take a snapshot of the current view on a new window. Right click on the picture and re-save it to the location you want.
Alarm Out		Supervisor / Power User / Normal User	Click to force your alarm-out device to work. For example, when your alarm device is a buzzer, click this button and your buzzer will start to sound even if there's no alarm event.
Zoom-in / out*		Supervisor / Power User / Normal User	Click to zoom in / out the current image.
Max. Zoom-in / out*		Supervisor / Power User / Normal User	Click to zoom in the image to the largest / zoom out the image to its original size.
Focus near / far*		Supervisor / Power User / Normal User	Click to adjust the clearness of the video images.
DPTZ		Supervisor / Power User / Normal User	Click to enable digital PTZ functions with zoom-in ratio up to 16X.
Focus Zone		Supervisor / Power User / Normal User	Click to assign the point for focus adjustment. <i>This function will be disabled when DPTZ is enabled.</i>

* For selected models only

2.3 Digital PTZ (DPTZ) Operations



This camera has PTZ capability, i.e. digital PTZ (hereafter called "DPTZ"), for wide area monitoring.

STEP1: Click "DPTZ" to show the DPTZ control panel.

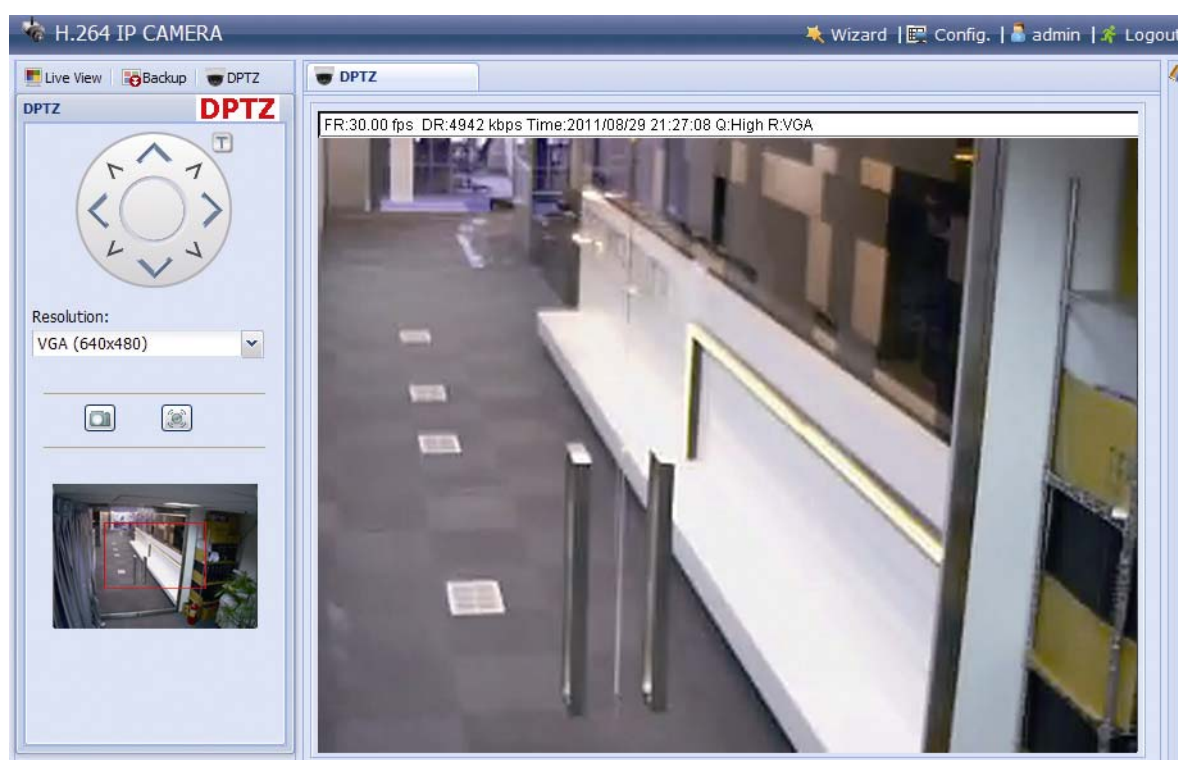
➤ Type A:

















STEP2: Select the functions when needed:

FUNCTION	ICON	DESCRIPTION
Resolution	--	Select the video resolution for the DPTZ function. Only "VGA" and "QVGA" are available.
Take snapshots		Click to take a snapshot of the current view on a new window. Right click on the picture and re-save it to the location you want.
Alarm Out		Click to force your alarm-out device to work. For example, when your alarm device is a buzzer, click this button and your buzzer will start to sound even if there's no alarm event.

➤ Type B:











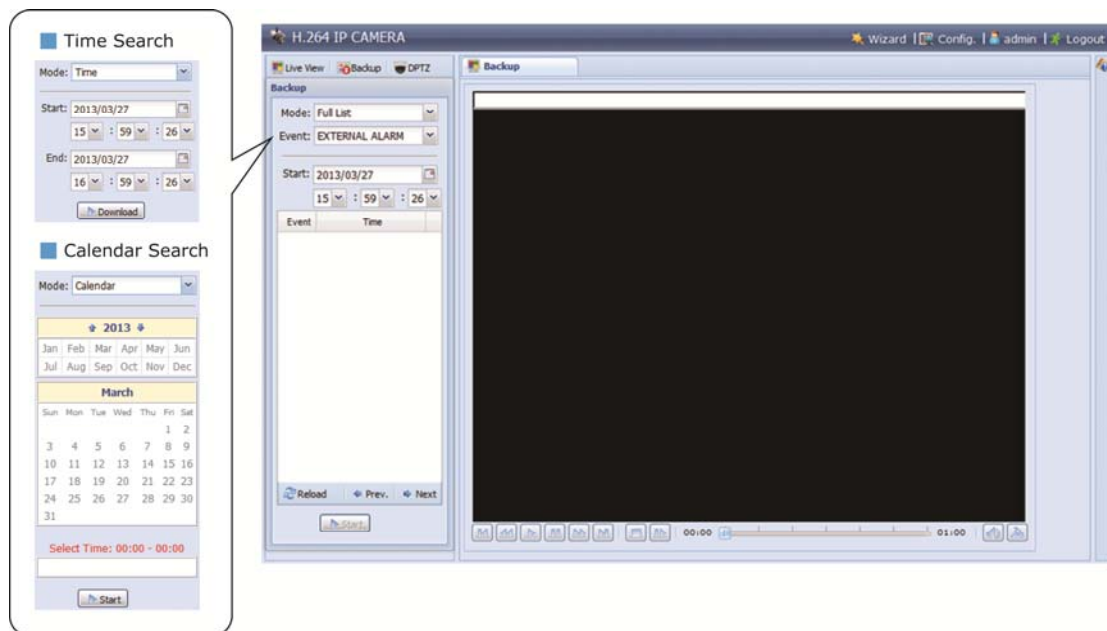

FUNCTION	ICON	DESCRIPTION
Moving panel	--	When  is selected, the moving control panel will be shown to move the picture after zoom-in is performed.
Take snapshots		Click to take a snapshot of the current view on a new window. Right click on the picture and re-save it to the location you want.
Fit to screen		The selected resolution is resized to fit into the current live view size. <i>This icon doesn't work when the selected resolution is VGA or QVGA.</i>
Zoom in / out	 / 	Click  once to enlarge the picture by 1X, and click  once to restore the zoom ratio by 1X.
Max. zoom in / out	 / 	Click  once to enlarge the picture to the max zoom ratio by 16X, and click  once to restore the picture ratio to 1X.
Focus near / far	 / 	Click to adjust the clearness of the video images.
Focus Zone		Click to assign the point for focus adjustment. <i>This function will be disabled when DPTZ is enabled.</i>

2.4 Event Record Search & Playback

This camera can only save up to three alarm recordings.

Note: To save more recorded data, it's recommended to use this camera with a compatible NVR.



	Previous / Next Hour	Click to jump to the next / previous time interval in an hour, for example, 11:00 ~ 12:00 or 14:00 ~ 15:00, and start playing the earliest event video clip recorded during this whole hour.
	Fast Forward	Increase the speed for fast forward. Click to get 2X, 4X, 8X & 16X speed forward eventually.
	Fast Rewind	Increase the speed for fast rewind. Click to get 2X, 4X, 8X & 16X speed rewind eventually.
	Play	Click to play the current video clip.
	Pause	Click to pause the video playback.
	Stop	Click to stop the video playback.
	Step	In the pause mode, click to get one frame forward.
	Audio	Click to mute the playback if necessary, and click again to restore.
	Download	Click to download the current video clip to the specified path in your PC. <i>The downloaded video can only be opened by our own video player. Please go to "General" → "Maintenance" to download the video player, or get the player from the CD supplied with the sales package.</i>

3. CAMERA CONFIGURATIONS

Users can further configure this network camera by accessing via Internet Explorer.

3.1 System configuration menu

Click “Config.” to enter the configuration page.

The functions are categorized into six menus: Network, Camera, Record Timer, Storage, Trigger and General.

- For details about “Network”, please refer to “3.2 Network” at page 11.
- For details about “Camera”, please refer to “3.3 Camera” at page 17.
- For details about “Record”, please refer to “3.3.5 Privacy Mask (For selected models only)

You can cover certain areas on the camera image with privacy masks.

Item	Description
Mosaic Size	Choose the mosaic size of the privacy mask. The options are: 8x8, 32x32, and 64x64.
Privacy Mask Name	Name your privacy mask.
Function	Select “On” to enable the privacy mask function.
Mosaic	Select “ON” to have the mosaic effect.
Color	Select “ON” to color the privacy mask. In the meantime, you can’t see the mosaic effect.
Mask Color	Select the color for the privacy mask.
Transparency	Select the transparency for your privacy mask. The options are: 0%, 25%, 50%, and 100%.

- 3.4 Record” at page 19.
- For details about “Storage”, please refer to “3.5 Storage” at page 20.
- For details about “Trigger”, please refer to “3.6 Trigger” at page 21.
- For details about “General”, please refer to “3.7 General” at page 22.

Main Menu	Sub-Menu	Reference
Network	Network	Configure network settings.
	QoS	Limit the data flow for live streaming.
	DDNS	Enter DDNS information when the network type is PPPOE or DHCP.
	SNTP	Synchronize your camera time with the networked computer systems.
	FTP	Enter the FTP information for event notifications when “FTP” is chosen in “Trigger” → “Trigger”.
	Mail	Enter Email information for event notifications when “Email” is chosen in “Trigger” → “Trigger”.
	SMS	Enter text messaging information for SMS notifications when “SMS” is chosen in “Trigger” → “Trigger”.
	Filter	Choose to permit or block the IP address(es) which can access this camera.
	UPnP	<i>*Suitable for Windows-based operating system.</i> Allow this camera to be detected among devices within the same network area for easy and quick usage.
	Bonjour	<i>*Suitable for Apple Mac-based operating system.</i> Allow this camera to be detected among devices within the same network area for easy and quick usage.
	RTP	Set the parameters for video data transmission when you’re using multimedia other than web browsers and Video Viewer for remote access.
Camera	Camera	1. Rename the camera. 2. Change the place where the camera name is shown on the screen.
	Video	Adjust video-related settings in different video format.
	Color	Adjust the color performance.
	Advance	Adjust the camera parameters if necessary.
Record	Record	Configure the record function.
	Record Timer	Schedule external alarm recording.
Storage	Memory	Check the current storage capacity and clear all recorded data when needed.
Trigger	Trigger	1. Enable / disable the motion detection. 2. Set the motion detection area. 3. Configure how the camera reacts for any event.
General	General	1. Select the language of the web browser. 2. Check the MAC address of the camera. 3. Lock camera access after the specified time.
	Time	Set daylight saving time and the current time.
	Server Log	Check the system event logs.
	Online	Check the current online user(s).
	Account	1. Create a new user account with different access privilege. 2. Modify or delete an existing user account.
	Google Maps	Allow you to know where the network camera is.
	Maintenance	1. Check the current firmware version and upgrade your camera. 2. Copy system configurations. 3. Reboot the camera. 4. Download the video player to play the recorded data.

3.2 Network

3.2.1 Network

You can set the network configuration of the network camera depending on your network type.

For details, please refer to “Advanced Network Setup” from www.surveillance-download.com/user/m359a.swf.

The screenshot shows the 'Network Configuration' web interface. It features several input fields: 'IP Type' with radio buttons for 'Static IP', 'PPPoE', and 'DHCP' (selected); 'Server IP' (192.168.1.10); 'Gateway' (192.168.1.1); 'Net Mask' (255.255.255.0); 'Port' (88); 'DNS1' (8.8.8.8); 'DNS2' (168.95.1.1); and 'MAC Address' (00:0E:53:EB:62:10). At the bottom, there are 'Save' and 'Reload' buttons.

3.2.2 QoS

QoS, Quality of Service, is the ability to control the data flow for real-time streaming. This function is important if your network bandwidth is insufficient and you have other devices to share the network bandwidth.

Check “QoS Enable”, and set the max. upload rate from 256 to 10240 kbps.

The screenshot shows the 'QoS Configuration' web interface. It includes radio buttons for 'QoS' (Enable selected, Disable unselected), a dropdown menu for 'Interface' (Ethernet), and a text input for 'Max. Upload Rate' (4096) followed by 'kbps'. 'Save' and 'Reload' buttons are at the bottom.

3.2.3 DDNS

Select “On” when the selected network type in “Network” is “PPPOE” or “DHCP”.

For details, please refer to “Advanced Network Setup” from www.surveillance-download.com/user/m359a.swf.

The screenshot shows the 'DDNS Configuration' web interface. It features radio buttons for 'DDNS' (Enable selected, Disable unselected), a dropdown for 'System Name' (default), a text input for 'Hostname' (MAC000e531d6ff1) with a domain (.ddns.eagleeyes.tw) to its right, and a text input for 'E-Mail' (manager@tech.com). 'Save' and 'Reload' buttons are at the bottom.

3.2.4 SNTP

SNTP (Simple Network Time Protocol) is used to synchronize your camera time with the networked computer..

The screenshot shows the 'SNTP Configuration' web interface. It includes a dropdown for 'GMT' (GMT+08:00 Taipei), a text input for 'NTP Server' (tock.stdtime.gov.tw), a dropdown for 'Sync. Period' (Daily), and a text input for 'Server Time' (2011-08-30 20:34:42). A 'Sync.' button is located below the 'Server Time' field. 'Save' and 'Reload' buttons are at the bottom.

Function	Description
GMT	Once users choose the time zone, the network camera will adjust the local area time of the system automatically.
NTP Server	Simply use the default SNTP server (For example, tock.stdtime.gov.tw) or change to another server with which users are familiar.
Sync. Period	Select “Daily” to synchronize the camera time with the network time every day or “None” to turn off this function.
Sync	Click and the network camera will synchronize the time with the network time.

3.2.5 FTP

Enter the detailed FTP information and click “Save” to confirm. The information you set here will be applied when “FTP” is selected in “Trigger” → “Trigger”.

FTP Configuration

Username:

Password:

Server:

Port:

Directory:

3.2.6 MAIL

Enter the detailed e-mail information and click “Save” to confirm. The information you set here will be applied when “Email” is selected in “Trigger” → “Trigger”.

SMTP Configuration

SMTP Server:

Port:

Mail From:

SSL Encryption: Yes No

Verify Password: Yes No

Username:

Password:

E-Mail Address List

E-Mail Address:

Receiver Name	E-Mail Address
boss	boss@tech.com

Function	Description
SMTP Server	Enter the SMTP server address provided from your e-mail system supplier.
Port	Enter the port number provided from your e-mail system supplier. If this column is left blank, the e-mail server will use port 25 to send e-mails.
Mail From	Enter the name of the sender.
SSL Encryption	Select “Yes” if your e-mail server is using SSL encryption to protect your e-mail content from unauthorized access.
Verify Password	Some mail servers are required to verify the password. Please enter the “user name” and “password”.
E-Mail Address List	Add the e-mail address(s) of the assigned recipient(s).
Test	When all information is entered, click “Test Mail” to try if the receipt.

3.2.7 SMS

Note: Before using this function, you need to apply an account and get an API ID from the mobile messaging company, such as Clickatell and EVERY8D. For details, please refer to "APPENDIX 4 API ID APPLICATION FOR SMS MESSAGING" at page 39.

Enter the detailed information needed for text messaging, and click "Save" to confirm. The information you set here will be applied when "SMS" is selected in "General" → "Trigger".

The screenshot shows the 'SMS Configuration' interface. It contains the following fields and controls:

- System:** A dropdown menu with 'clickatell' selected.
- Username:** A text input field containing 'tech'.
- Password:** A text input field with masked characters '*****'.
- API ID:** A text input field containing '3281378'.
- Recipient:** A text input field containing '+886912665475' with a small flag icon to the left.
- Transfer Interval:** A dropdown menu with '15' selected, followed by the text 'Minute(s)'. A 'Reset Counter' button is located to the right of this field.
- Message:** A text area containing '[192.168.1.10] unauthorized access!'. A checkbox labeled 'Include Hostname or IP' is checked and located to the right of the text area.

At the bottom of the form, there are three buttons: 'Save', 'Test', and 'Reload'.

Function	Description
System	The text messaging service provider is Clickatell.
User name / Password	Enter the account user name and password you created in Clickatell.
API ID	Enter the API ID you applied from Clickatell.
Recipient	Click "Add" to enter the phone number, including the country code, to receive the text message. Five sets of phone numbers are allowed.
Transfer Interval	Set the interval time in minutes between two-message sending. The options are 0, 15, 30 & 60.
Reset Counter	Click to restart the text messaging, and the SMS will be sent after the specified time interval since you click this button.
Message	Enter the text content (up to 70 characters) you want to send with the text message.
Test	To know whether your SMS setting is correct, click this button to immediately send a SMS to your phone. Note: This testing is not free and you will be charged for SMS sending base on your local rate.

3.2.8 Filter

Choose to permit or block the IP address(es) which can access this camera, and click “Save” to confirm.

Function	Description
Filter Configuration	
Error Count	Set the maximum count for login failure. When the maximum count is reached, the IP address trying to access the network camera will be locked.
Error Lock Time	Set the lock time in minutes when the maximum count of error login for an IP address is reached.
Echo Request	Select “Non-Block” to allow other users to use the ping command to detect the IP address of your network camera, or “Block” to deny the ping command request.
IP/MAC Filter Configuration	
IP/MAC Filter	Choose to enable or disable the filter function.
IP/MAC Filter Policy	If “Enable” is selected, choose whether you want to permit (Allow) or block (Deny) the IP address list below.
IP/MAC Filter Rules	
Rule	<ul style="list-style-type: none"> To add an item to the IP address list, key in the IP address in “Rule”, and click “Add”. To remove an existing item in the IP address list, click the item you want to remove, and click “Delete”.

3.2.9 UPnP / Bonjour

“UPnP” stands for “Universal Plug and Play”, which allows devices to connect seamlessly in the home and corporate environments and simplify installation of computer components, and is only suitable for Microsoft Windows-based operating system.

“Bonjour” functions the same as “UPnP”, but it’s only suitable for Apple Mac-based operating system.

➤ UPnP

➤ Bonjour

Check “Enable” to allow the network camera to be detected among devices within the same network area, and set the identification name of the camera in “Friendly name”.

When this function is activated, the other PC within the same domain as this camera will be able to search this camera in:

- “Network Neighbor” with the identification name set in “Friendly name” for Windows-based PC, or
- “🔍” (finder) or “Bookmark” with the identification name set in “Device Name” for Mac-based PC.

Double-click it to quickly open the web browser for camera access.

Port Mapping (Available only in UPnP)

This function can eliminate the need to additionally access the router for port forwarding.

For details, please refer to “Advanced Network Setup” from www.surveillance-download.com/user/m359a.swf.

Note: Before using this function, make sure your router supports UPnP, and this function is enabled. If not, please access your router additionally for port forwarding.

When “Port Mapping” is set to “Enable”, the system will automatically assign an IP address or port number for you if no IP address or port number is entered.



The screenshot shows the 'Port Mapping Configuration' window. It has a title bar 'Port Mapping Configuration'. Below the title bar, there are two radio buttons: 'Enable' (selected) and 'Disable'. Below that, a text box says 'Your IP-Camera is accessible from the other side of the router using the following URL: http://60.248.97.4:80 or https://60.248.97.4:59207.' There are three input fields: 'Router IP:' (empty), 'HTTP Port:' (80), and 'HTTPS Port:' (59207). Below the input fields, there is a note: '*If set to blank or 0, a port number will be set automatically upon enable.' At the bottom, there are two buttons: 'Save' and 'Reload'.

Note: When the configurations are saved successfully, you’ll see a message indicating the IP address and port number assigned to this network camera.

3.2.10 RTP

The Real-time Transport Protocol (RTP) is an Internet protocol standard to manage the real-time transmission of multimedia, such as VLC player.

The media player you want to use for remote access must support RTP transmission for this function to work normally.

Note: When you’re about to end the remote access, please press the stop button on your media player first, and then close the program. This is to ensure the server receives the stop command, and also help to protect the server from redundant data transmission.

➤ Type A

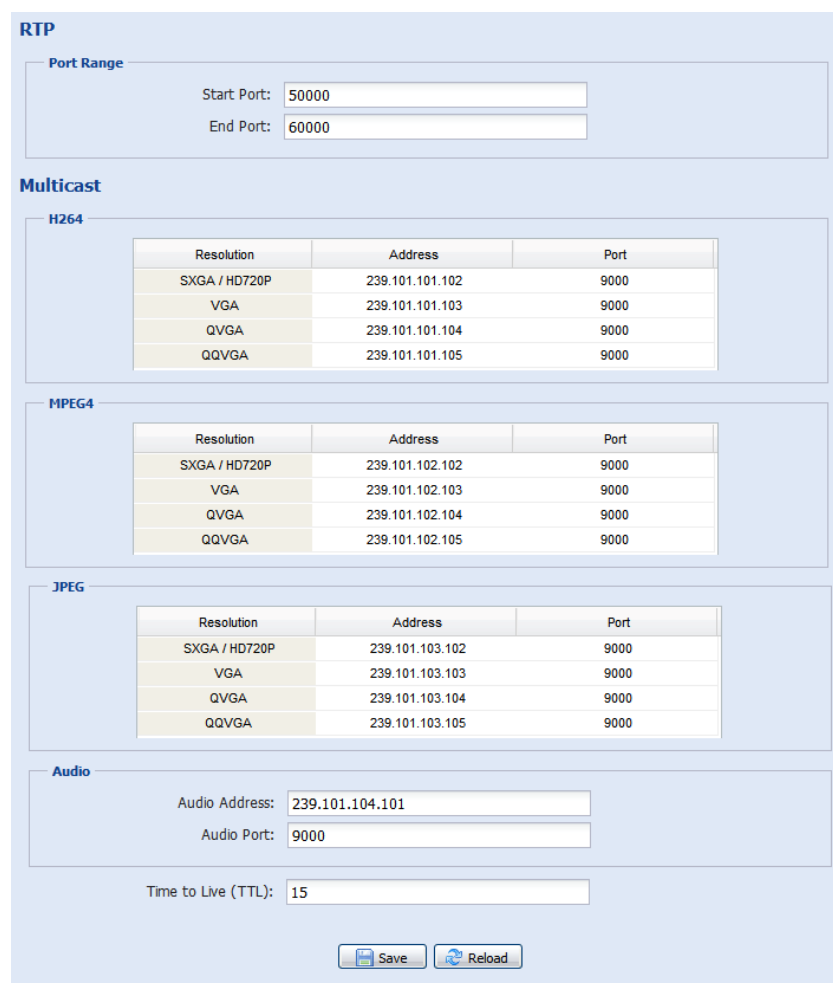

The screenshot shows the 'RTP' configuration interface. It has a title bar 'RTP'. Below the title bar, there is a section 'Port Range' with two input fields: 'Start Port:' (50000) and 'End Port:' (60000). Below that, there is a section 'Multicast' with three sub-sections: 'H264', 'MPEG4', and 'JPEG'. Each sub-section has a table with columns 'Resolution', 'Address', and 'Port'. The 'H264' table has rows for SXGA / HD720P, VGA, QVGA, and QQVGA with addresses 239.101.101.102, 239.101.101.103, 239.101.101.104, and 239.101.101.105 respectively, all with port 9000. The 'MPEG4' table has rows for SXGA / HD720P, VGA, QVGA, and QQVGA with addresses 239.101.102.102, 239.101.102.103, 239.101.102.104, and 239.101.102.105 respectively, all with port 9000. The 'JPEG' table has rows for SXGA / HD720P, VGA, QVGA, and QQVGA with addresses 239.101.103.102, 239.101.103.103, 239.101.103.104, and 239.101.103.105 respectively, all with port 9000. Below the tables, there is a section 'Audio' with two input fields: 'Audio Address:' (239.101.104.101) and 'Audio Port:' (9000). At the bottom, there is a 'Time to Live (TTL):' input field (15) and two buttons: 'Save' and 'Reload'.

Function	Description
■ Port Range The port range used by RTP is limited, and preserving 100 ports between the start port and end port is necessary.	
Start Port	The range of the start port is 1024 ~ 65434.
End Port	The range of the end port is 1124 ~ 65534.
■ Multicast	
Address and port for H264 / MPEG4 / JPEG transmission	Set a specific address and port for multicast of each stream format (H264/ MPEG4/ JPEG). The range of the address is limited between 224.0.0.1 ~ 239.255.255.255. The port for multicast must be an even number.
Address and port for audio transmission	Set a specific address and port for multicast of audio. The range of the address is limited between 224.0.0.1 ~ 239.255.255.255. The port for multicast must be an even number.
Time to Live (TTL)	The range of Time to Live of the package is between 1 ~ 255. As soon as Time to Live of the package is 0, it will be dropped.

➤ Type B

Port Range

Start Port:

End Port:

Video

Profile	Address	Port	Time to Live (TTL)
1	239.101.101.101	9000	15
2	239.101.101.102	9000	15
3	239.101.101.103	9000	15
4	239.101.101.104	9000	15

Audio

Profile	Address	Port	Time to Live (TTL)
1	239.101.102.101	9000	15
2	239.101.102.102	9000	15
3	239.101.102.103	9000	15
4	239.101.102.104	9000	15

Function	Description
■ Port Range The port range used by RTP is limited, and preserving 100 ports between the start port and end port is necessary.	
Start Port	The range of the start port is 1024 ~ 65434.
End Port	The range of the end port is 1124 ~ 65534.
■ Video	
Address and port for video transmission	Set a specific address and port for multicast of profile 1 ~ 4. The range of the address is limited between 224.0.0.1 ~ 239.255.255.255. The port for multicast must be an even number.
■ Audio	
Address and port for audio transmission	Set a specific address and port for multicast of audio. The range of the address is limited between 224.0.0.1 ~ 239.255.255.255. The port for multicast must be an even number.

3.3 Camera

3.3.1 Camera

Rename the camera, and change the place where the camera name is shown on the screen, UP-LEFT / UP-RIGHT / DOWN-LEFT / DOWN-RIGHT. "Snapshot Path" is used to specify the path to save snapshot files.

Type A

Type B

3.3.2 Video

Adjust video-related settings in different video format.

- "Quality" is related to image clearness.
- "FPS" is related to the fluency of the video. The more the FPS, the more fluent the video.
- "Max Bit Rate" is the maximum limitation of data transmission in the selected image format and resolution.

Take 2 megapixel model as an example below. For 1.3 megapixel model, please refer to its actual display.

Note: QQVGA is for mobile surveillance only.

➤ Type A:

Resolution	Quality	FPS	Max Bit Rate
HD1080P	HIGH	30	8000
HD720P	HIGH	30	8000
VGA	HIGH	30	3000
QVGA	HIGH	30	3000
QQVGA	HIGH	30	3000

Resolution	Quality	FPS	Max Bit Rate
HD1080P	HIGH	15	8000
HD720P	HIGH	30	8000
VGA	HIGH	30	3000
QVGA	HIGH	30	3000
QQVGA	HIGH	30	3000

Resolution	Quality	FPS
HD1080P	HIGH	30
HD720P	HIGH	30
VGA	HIGH	30
QVGA	HIGH	30
QQVGA	HIGH	30

➤ Type B:

Profile	Media Type	Resolution	Quality	FPS	Max Bit Rate
1	H264	1920x1080	BEST	30	8000
2	H264	720x480	HIGH	30	5000
3	H264	352x240	HIGH	30	5000
4	JPEG	352x240	HIGH	30	5000

3.3.3 Color

Adjust the color performance from Brightness, Contrast, Saturation, and Hue (for selected models only). Click and drag the slider to preview the color change on the right side of this page and adjust the image color.

To restore the default values, click "Back to Default".

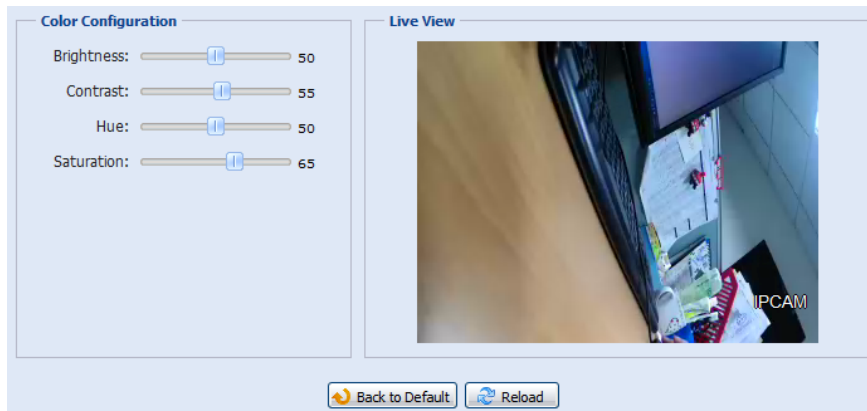

3.3.4 Advanced

Adjust the camera parameters if necessary.

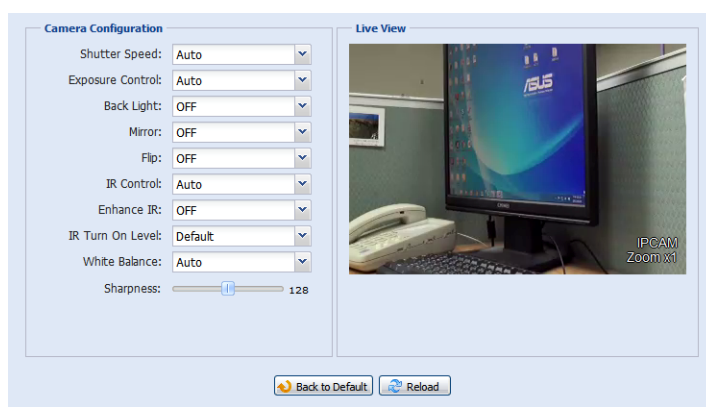

Item	Description
Shutter Speed	Set the shutter speed based on your need. The options are: Up to 1/10 sec, Up to 1/30, Up to 1/15, Up to 1/6, Up to 1 and Up to 2.
Exposure Control*	This function is used to synchronize the shutter time to the fluorescent light to suppress image flickering.
Back light*	It is the function to adjust the image to compensate for an area that is overpowered by brightness because of excessive light. The image will be properly exposed for clearness. Select to activate (ON) or disable (OFF) this function. Note: This function is available only in the day mode.
Mirror	Select "ON" to rotate the images horizontally based on your installation situation when necessary.
Flip	Select "ON" to rotate the image 180° when necessary.
De-noise*	Click and drag the slider to adjust the level from 0 ~ 10 to decrease the noise shown in the dark environment.
IR Control	Select "Auto" to automatically enable IR LEDs at night or in the dark environment, "On" to always enable IR LEDs, or "OFF" to disable this function.
Enhance IR	Select "On" to enhance IR LEDs performance.
IR Turn On Level	Select the level for IR light to activate.
White Balance	Process the current image to retain color balance over a color temperature range. The options are: Auto, Incandescent Light, Cool Light, sun Light, Cloudy & Sun Shade.
Sharpness	Sharpness enhances the clarity of image detail by adjusting the aperture and sharpening the edges in the pictures. Hold and drag the slider to adjust the level of sharpness from 0 ~ 100. The higher the value, the sharper the image.
Wide Dynamic Range*	Wide Dynamic Range (WDR) is used when users need to increase image recognizability in overexposure and dark areas. The options are: LOW / MIDDLE / HIGH / OFF

*Selected models only

3.3.5 Privacy Mask (For selected models only)

You can cover certain areas on the camera image with privacy masks.

Item	Description
Mosaic Size	Choose the mosaic size of the privacy mask. The options are: 8x8, 32x32, and 64x64.
Privacy Mask Name	Name your privacy mask.
Function	Select "On" to enable the privacy mask function.
Mosaic	Select "ON" to have the mosaic effect.
Color	Select "ON" to color the privacy mask. In the meantime, you can't see the mosaic effect.
Mask Color	Select the color for the privacy mask.
Transparency	Select the transparency for your privacy mask. The options are: 0%, 25%, 50%, and 100%.

3.4 Record

3.4.1 Record

In “Record Configuration”, you can:

- Enable or disable the alarm record function. When “Enable” is set to “No”, the alarm record function is disabled even if you enable it in other configuration pages.
- Select if the data should be overwritten when the memory storage is full.
- Select the video resolution for event recording.

Note: The higher resolution you choose, the more accuracy and higher image quality the recording will be, but the faster the memory storage is consumed and become full

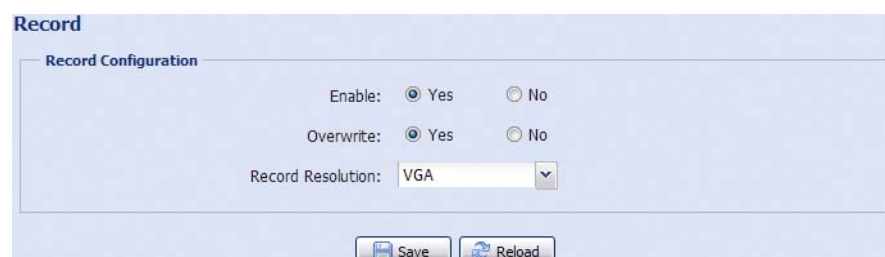

3.4.2 Record Timer

To schedule alarm recording, enable it, and select the day and time for recording.

Note: The timer must be enabled for the record function to work properly.

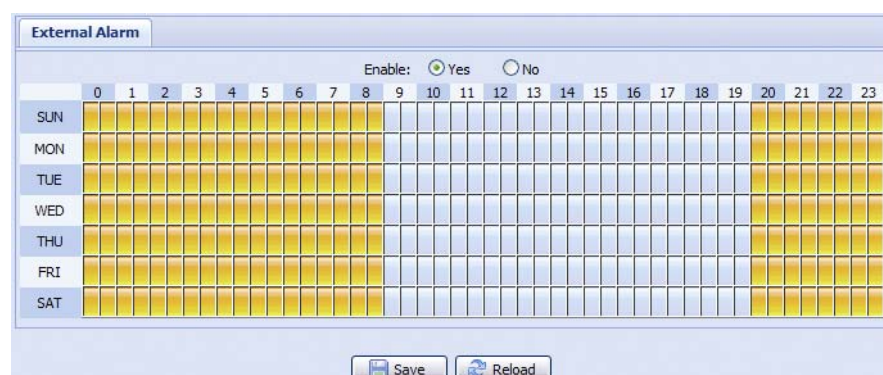

3.5 Storage

3.5.1 Memory

In “Memory”, you can check the remaining capacity for recording, or clear all recorded data saved if needed.

Note: The recorded data will be removed also when you reset or reboot this camera.

Note: To save more recorded data, it's recommended to use this camera with the compatible NVR.

Note: To know the total recording time per recording resolution, please refer to “APPENDIX 6 RECORDING TIME TABLE” at page 42.

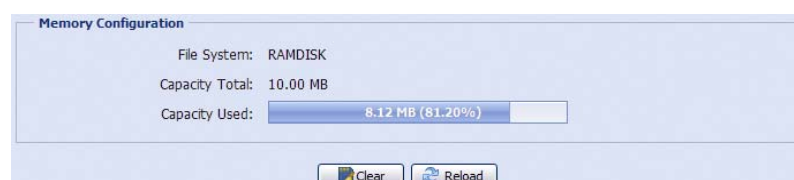

The total capacity may vary depending on different models. Please check the actual display of your model.

3.6 Trigger

3.6.1 Trigger

You can configure how this camera reacts when there's an alarm or motion event.

◆ Detect

Item	Description
External Alarm	Enable or disable detection from external alarm-in device, and click the title "External Alarm" (in blue) to set "N.O." or "N.C." depending on the configuration of your alarm-in device.
Motion	<p>Enable or disable motion detection.</p> <p><i>Motion detection is not supported when the stream format is Motion JPEG.</i></p> <p>When "Enable" is selected, click "Detection" to enter the motion detection area setting page as follows:</p>  <p>Sensitivity: Set the detection sensitivity from the drop-down list: High, Normal or Low.</p> <p>Area Setting: Set the motion detection area by selecting the area grids with your mouse. Pink grids represent the area that is not being detected while the transparent grids are the area under detection. You can set multiple areas under detection. Click "Clear All" to set the whole area undetected. Click "Select All" to set the whole area under detection.</p>
Duration	Set the duration time for trigger recording (5 / 10 / 20 / 40 seconds).

◆ Action

Here defines how the camera delivers alerts to you for any event.

Item	Description
E-Mail	Select the event type you want to receive E-mail notifications when it occurs. Then, click the title "E-Mail" (in blue) to configure the media type (H264 / JPEG / MPEG4), file format (AVC / AVI), and record time (1 ~ 5 seconds) for the event video clip. The camera will send the captured video clip to the E-mail address(s) you assigned in "Network" → "Mail" once the selected event type occurs.
FTP	Select the event type you want to receive FTP notifications when it occurs. Then, click the title "FTP" (in blue) to configure the media type (H264 / JPEG / MPEG4), file format (AVC / AVI), and record time (1 ~ 5 seconds) for the event video clip. The camera will upload the captured video clip to the FTP site you assigned in "Network" → "FTP" once the selected event type occurs.
SMS*	Select the event type you want to receive a text message when it occurs. The camera will send a text message to the mobile phone number you assigned in "Network" → "SMS" once the selected event type occurs.
Alarm Out	Select the event type you want to trigger the alarm-out device to work when it occurs. Then, click the title "Alarm Out" (in blue) to configure the trigger rule (LOW / HIGH).
Record	Select the event type you want to enable event recording when it occurs.

*Selected models only

3.7 General

3.7.1 General

To change the language of UI interface, select from the drop-down list in "Language".

To lock camera access when it's not used after the specified time, select "5 MIN", "15 MIN" or "30 MIN" from the drop-down list of "Auto Lock Time", or select "NEVER" to disable this function.

Note: When the camera access is locked after the specified time, to resume camera access, please enter the password.

General

General Configuration

Language: English

Auto Lock Time: 5 MIN

MAC Address: 00:0E:53:E6:0D:90

Save Reload

3.7.2 Time

Set daylight saving time and the current time, and click "Save" to confirm.

Time

Time Configuration

OSD: Enable Disable

Date: 2011/08/30

Time: 21 : 16 : 41

Save Reload

Daylight Saving Time

Daylight Saving Time: Enable Disable

Start Time: August First Week Monday 6 : 0 (HH:MM)

End Time: October Fifth Week Monday 10 : 0 (HH:MM)

Adjust Time: 1 : 0 (HH:MM)

Save Reload

Function	Description
■ Time Configuration	
Date	Set the current date.
Time	Set the current time.
■ Daylight Saving Time Configuration	
Daylight Saving Time	Specify whether to use daylight saving time (Enable / Disable). If this function is enabled, set the time period (Start Time / End Time), and adjust the daylight saving time in hours (Adjust Time).

3.7.3 Server Log

To quickly search the system logs you want by event type, click “Prev. Page” or “Next Page” to find the logs you want, or check the event type(s) and click “Reload” to start searching.

To clear all system event logs, click “Clear All”.

Server Log List

No.	Event	Time	Result
1	Remote Login	2011/08/30 20:54:41	admin
2	Remote Login	2011/08/30 20:29:58	admin
3	Remote Login	2011/08/30 18:22:08	admin
4	SNTP Update	2011/08/30 18:20:06	Failed
5	Remote Login	2011/08/30 18:20:03	admin
6	Power On	2011/08/30 18:19:24	ON
7	Power On	2011/08/30 18:18:46	OFF
8	Remote Login	2011/08/30 18:11:21	admin
9	Remote Login	2011/08/30 18:11:18	admin
10	Remote Login	2011/08/30 18:07:10	admin
11	Remote Login	2011/08/30 18:03:19	admin
12	Remote Login	2011/08/30 18:02:15	admin
13	Remote Login	2011/08/30 18:02:07	admin
14	Remote Login	2011/08/30 18:01:51	admin
15	Remote Login	2011/08/30 17:57:01	admin
16	Remote Login	2011/08/30 17:56:55	admin
17	Remote Login	2011/08/30 17:56:53	admin
18	Remote Login	2011/08/30 17:54:44	admin
19	SNTP Update	2011/08/30 17:50:48	Failed
20	Power On	2011/08/30 17:50:07	ON

[Prev. Page](#)
[Next Page](#)
[Reload](#)
[Clean All](#)

3.7.4 Online

You can check the current online user(s) with respective online information. To refresh the list, click “Reload”.

- To allow anonymous login, select “Enable” in “Anonymous Viewer Login”.
- To disable image code verification at login, select “No” in “Login with CAPTCHA Image”.

Online Configuration

Anonymous Viewer Login: Enable Disable

Login with CAPTCHA Image: Yes No

Max Online User:

Username	IP Address	User Level	Media Type
admin	211.75.84.96	SUPERVISOR	H264
admin	60.248.97.4	SUPERVISOR	H264

[Reload](#)

[Save](#) [Reload](#)

3.7.5 Account

You can create a new account with different user access privilege, or delete or modify an existing account setting.

How to create a new account

Step1: Click “New”, and fill in the following columns.

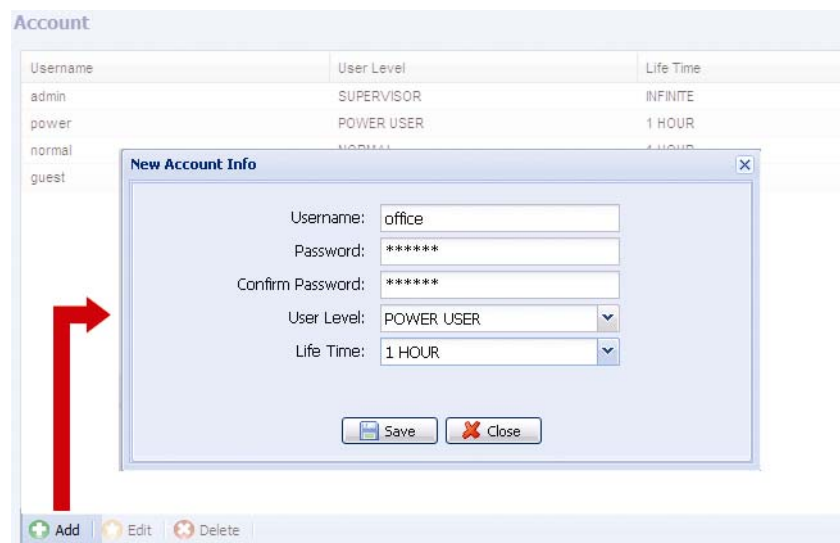

Column	Description
User Name	Set a user name that will be used for camera access. The user name allows up to 16 alphanumeric characters.
Password	Set the password that will be used for remote login. The password allows up to 16 alphanumeric characters.
Confirm Password	Enter the password again to confirm.
User Level	Set the security level of an account to give the permission to control different functions. There are four user levels: SUPERVISOR, POWER USER, NORMAL USER and GUEST.
Life Time	Select how long this account is allowed to stay online (1 MIN / 5 MIN / 10 MIN / 1 HOUR / 1 DAY / INFINITE)

Step2: Then, click “Save” to save your setting and create a new account.

How to modify or delete an existing account

Step1: Select the account you want to modify or delete.

Step2: To modify the account, click “Edit” to change the settings, and click “Save”.
To remove the account, click “Delete”.

Note: It's not allowed to remove an account when there's only one account in the account list.

3.7.6 Google Maps

This function is used to let you know where the network camera is.

The system will prompt you to apply a Google Maps Key if your access is denied. Please follow the instructions below when you're denied:

Step1: Click “Sign up for a Google Maps key” to enter the application page.

Step2: Check the terms and conditions, and enter the IP address of the network camera. Then, click “Generate API Key”.

Step3: Copy the generated API key, and click “Update Google Maps Key” on the web browser to paste it.

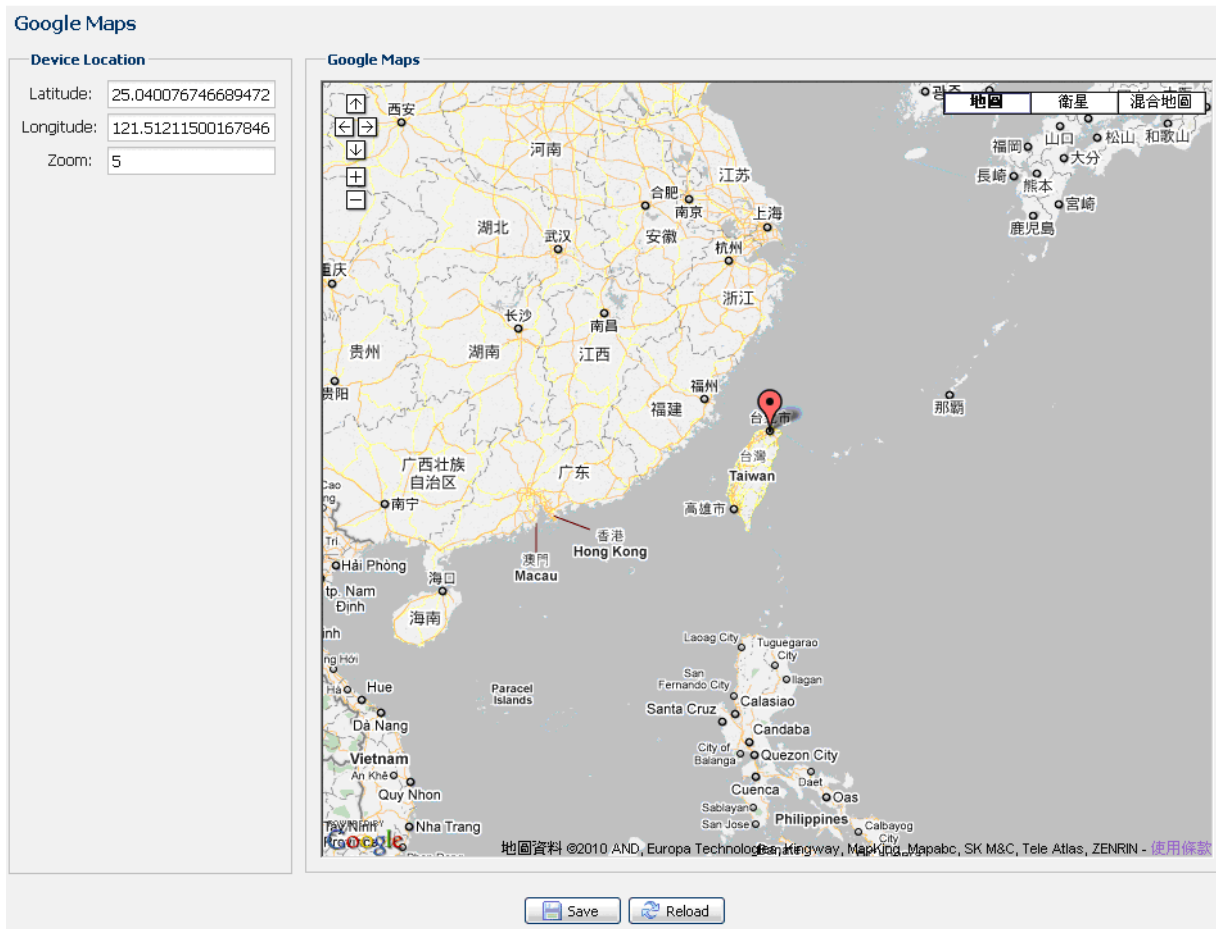

3.7.7 Maintenance

Firmware Upgrade

This function is used when users need to upgrade the camera for function scalability.

Note: Before using this function, make sure you have the correct upgrade files provided by your installer or distributor.

Note: The event videos saved in the camera will be removed after firmware upgrade. Make sure you've copied important events to your PC before firmware upgrade.

Step1: Select “” to browse to where you save the upgrade files, and select them one by one until all files are selected (up to four files).

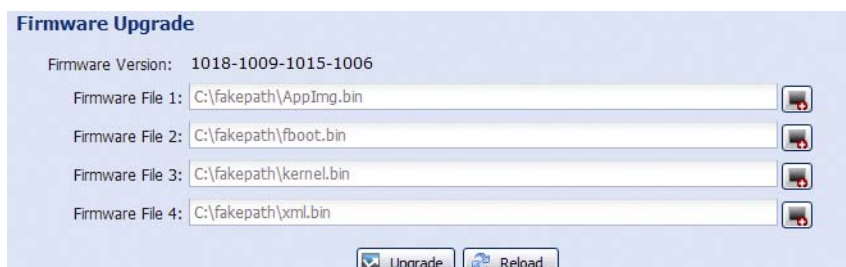

Step2: Select “Upgrade” to start system upgrading.

Note: You'll be prompted to keep current configurations. It's recommended to keep them, or all configurations will be restored to default values after upgrade.

Note: It takes a few minutes to finish the upgrade process. Do not disconnect the power during firmware upgrade, or the upgrade may be failed. The camera will reboot after the upgrade.

System Configuration Backup

This function is used to copy your system configuration to a "System.bin" file.

You may import the same system configuration to another camera, or restore your system configuration when the camera is reset to default values.

Select "System.bin" in "Firmware Upgrade", and select "Upgrade" to import the system configuration.

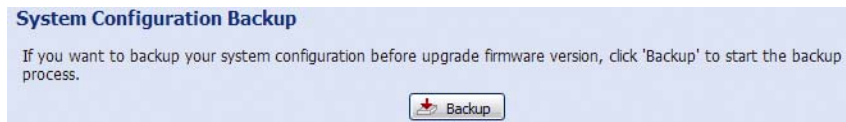

System Reboot

Select "Reboot" to restart your camera if needed.

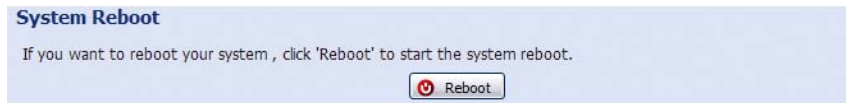

Player Download

To see the event video clips downloaded to your PC, you need to first install our own video player in your PC. Select "Free Download" to download the video player, and double click the file to install it.

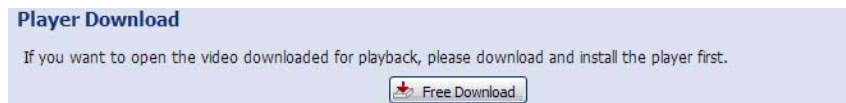

APPENDIX 1 PRODUCT SPECIFICATIONS

	Model 1	Model 2
Network		
LAN Port	YES	
LAN Speed	10/100 Based-T Ethernet	
Supported Protocols	DDNS, PPPoE, DHCP, NTP, SNTP, TCP/IP, ICMP, SMTP, FTP, HTTP, RTP, RTSP, RTCP, IPv4, Bonjour, UPnP, DNS, UDP, IGMP, QoS	
Number of Online Users	10	
ONVIF Compatible	YES	
Security	(1) Multiple user access levels with password (2) IP address filtering (3) Digest authentication	
Remote Access	(1) Internet Explorer on Windows operating system (2) 16CH Video Viewer on Windows & MAC operating system (3) EagleEyes on iPhone, iPad & Android mobile devices	
Video		
Video Compression	H.264 / MPEG4 / MJPEG	
Resolution	1080P, SXGA, 720P, VGA, QVGA	SXGA, 720P, VGA, QVGA
Frame Rate	30fps	
Multiple Video Streaming	4 (H.264, MJPEG, MPEG4)	
General		
Image Sensor	1/2.9" SONY CMOS image sensor	1/4" SONY CMOS image sensor
Min Illumination	1 Lux / F1.4, 0 Lux (LED ON)	
S/N Ratio	More than 48dB (AGC off)	
Electronic Shutter	1/2 to 1/10,000 sec	
Lens	f2.8 ~ 12mm / F1.4 ~ F2.8	
Viewing Angle	Wide: 109° (Horizontal) / 76° (Vertical) / 116° (Diagonal) Tele: 24° (Horizontal) / 13.5° (Vertical) / 27° (Diagonal)	Wide: 66° (Horizontal) / 52° (Vertical) / 90° (Diagonal) Tele: 16° (Horizontal) / 10° (Vertical) / 22° (Diagonal)
IR LED	2 Units	
IR Effective Range **	Default : up to 25 meters IR Enhanced Mode : up to 35 meters	
IR Shift	YES	
IRIS Mode	AES	
White Balance	ATW	
AGC	Auto	
WDR	NO	
POE (Power-over-Ethernet)	YES (IEEE 802.3af)	
External Alarm I/O	YES (1 input / 1 output)	
Micro SD Card Slot	YES	
Heater	NO	
IP Rating	IP66	
Operating Temperature	-20°C ~ 40°C	
Power Source (±10%)	12V / 1.5A	
Power Consumption (±10%)	PoE & PoN: 11.8W; DC Adapter: 9.5W (IR On)	PoE & PoN: 13.8W; DC Adapter: 11W (IR On)
Others		
Mobile Surveillance	iPad / iPhone / Android mobile device	
Event Notification	FTP / Email / SMS	
Digital Pan / Tilt / Zoom	YES	
Motion Detection	YES	
RTC (real-time clock)	YES	
Minimum Web Browsing Requirements	<ul style="list-style-type: none"> • Intel core i3 or higher, or equivalent AMD • 2GB RAM • AGP graphics card, Direct Draw, 32MB RAM • Windows 7, Vista & XP, DirectX 9.0 or later • Internet Explorer 7.x or later 	

* The specifications are subject to change without notice. ** Dimensional tolerance: ± 5mm

	Model 3	Model 4
■ Network		
LAN Port	YES	
LAN Speed	10/100 Based-T Ethernet	
Supported Protocols	DDNS, PPPoE, DHCP, NTP, SNTP, TCP/IP, ICMP, SMTP, FTP, HTTP, RTP, RTSP, RTCP, IPv4, Bonjour, UPnP, DNS, UDP, IGMP, QoS	
Number of Online Users	10	
ONVIF Compatible	YES (Profile S)	
Security	(1) Multiple user access levels with password (2) IP address filtering (3) Digest authentication	
Remote Access	(1) Internet Explorer on Windows operating system (2) 16CH Video Viewer on Windows & MAC operating system (3) EagleEyes on iPhone, iPad & Android mobile devices	
■ Video		
Video Compression	H.264 / MPEG4 / MJPEG	
Resolution	1080P, SXGA, 720P, VGA, QVGA	SXGA, 720P, VGA, QVGA
Frame Rate	30fps	
Multiple Video Streaming	4 (H.264, MJPEG, MPEG4)	
■ General		
Image Sensor	1/2.9" SONY CMOS image sensor	1/4" SONY CMOS image sensor
Min Illumination	1 Lux / F1.4, 0 Lux (LED ON)	
S/N Ratio	More than 48dB (AGC off)	
Electronic Shutter	1/2 to 1/10,000 sec	
Lens	f2.8 ~ 12mm / F1.4 ~ F2.8	
Viewing Angle	Wide: 109° (Horizontal) / 76° (Vertical) / 116° (Diagonal) Tele: 24° (Horizontal) / 13.5° (Vertical) / 27° (Diagonal)	Wide: 66° (Horizontal) / 52° (Vertical) / 90° (Diagonal) Tele: 16° (Horizontal) / 10° (Vertical) / 22° (Diagonal)
IR LED	2 Units	
IR Effective Range **	Default : up to 25 meters IR Enhanced Mode : up to 35 meters	
IR Shift	YES	
IRIS Mode	AES	
White Balance	ATW	
AGC	Auto	
WDR	NO	
POE (Power-over-Ethernet)	YES (IEEE 802.3at)	
External Alarm I/O	YES (1 input / 1 output)	
MicroSD Card Slot	YES	
Heater	YES	
IP Rating	IP66	
Operating Temperature	-40°C ~ 40°C	
Power Source (±10%)	12V / 1.5A	
Current Consumption	PoE & PoN: 19.5W; DC Adapter: 16.6W (IR On)	PoE & PoN: 18.6W; DC Adapter: 15.8 (IR On)
■ Others		
Mobile Surveillance	iPad / iPhone / Android mobile device	
Event Notification	FTP / Email / SMS	
Digital Pan / Tilt / Zoom	YES	
Motion Detection	YES	
RTC (real-time clock)	YES	
Minimum Web Browsing Requirements	(3) Intel core i3 or higher, or equivalent AMD (4) 2GB RAM (5) AGP graphics card, Direct Draw, 32MB RAM • Windows 7, Vista & XP, DirectX 9.0 or later • Internet Explorer 7.x or later	

(6) The specifications are subject to change without notice.
** Dimensional tolerance: ± 5mm

	Model 5	Model 6
■ Network		
LAN Port	YES	
LAN Speed	10/100 Based-T Ethernet	
Supported Protocols	DDNS, PPPoE, DHCP, NTP, SNTP, TCP/IP, ICMP, SMTP, FTP, HTTP, RTP, RTSP, RTCP, IPv4, Bonjour, UpnP, DNS, UDP, IGMP, QoS	
Number of Online Users	10	
ONVIF Compatible	YES (Profile S)	
Security	(1) Multiple user access levels with password (2) IP address filtering (3) Digest authentication	
Remote Access	(1) Internet Explorer on Windows operating system (2) 16CH Video Viewer on Windows & MAC operating system (3) EagleEyes on iPhone, iPad & Android mobile devices	
■ Video		
Video Compression	H.264 (Main Profile) / MJPEG	
Resolution	1080P to CIF	
Frame Rate	30/25 fps	
Multiple Video Streaming	4 (H.264, MJPEG)	
■ General		
Image Sensor	1/2.8" CMOS image sensor	
Min Illumination	0.1 Lux / F1.4(Wide)~F2.8(Tele), 0 Lux (LED ON)	
S/N Ratio	More than 48dB (AGC off)	
Electronic Shutter	1/10,000 ~ 1/7.5 (Slow shutter)	
Lens	f2.8 ~ 12mm / F1.4 ~ F2.8	
Viewing Angle	Wide: 97.4° (Horizontal) / 58.1° (Vertical) / 111.7° (Diagonal) Tele: 27.1° (Horizontal) / 15.2° (Vertical) / 31.1° (Diagonal)	
IR LED	2 Units	
IR Effective Range**	Default : up to 25 meters IR Enhanced Mode : up to 35 meters	
IR Shift	YES	
Smart Light Control	YES	
IRIS Mode	AES	
White Balance	ATW	
AGC	Auto	
WDR	YES	
POE (Power-over-Ethernet)	YES (IEEE 802.3af)	YES (IEEE 802.3at)
External Alarm I/O	YES (1 input / 1 output)	
MicroSD Card Slot	YES	
Privacy Mask	YES	
Heater	NO	YES
IP Rating	IP66	
Operating Temperature	-20°C ~ 40°C	-40°C ~ 40°C
Power Source (±10%)	12V / 1A	12V / 2A
Power Consumption (±10%)	PoE & PoN: 10.5W; DC Adapter: 8.4W	PoE & PoN: 23.5W; DC Adapter: 20W
■ Others		
Mobile Surveillance	iOS & Android	
Event Notification	FTP / Email / SMS	
Digital Pan / Tilt / Zoom	YES	
Motion Detection	YES	
RTC (real-time clock)	YES	
Minimum Web Browsing Requirements	<ul style="list-style-type: none"> • Intel core i3 or higher, or equivalent AMD • 2GB RAM • AGP graphics card, Direct Draw, 32MB RAM • Windows 7, Vista & XP, DirectX 9.0 or later • Internet Explorer 7.x or later 	

*The specifications are subject to change without notice

**Using IR enhanced mode and slow shutter speed, the distance can be extended even longer.

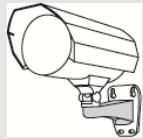
	Model 7	Model 8	Model 9
■ Network			
LAN Port	YES		
LAN Speed	10/100 Based-T Ethernet		
Supported Protocols	DDNS, PPPoE, DHCP, NTP, SNTP, TCP/IP, ICMP, SMTP, FTP, HTTP, RTP, RTSP, RTCP, IPv4, Bonjour, UPnP, DNS, UDP, IGMP, QoS		
Number of Online Users	10		
ONVIF Compatible	YES (Profile S)		
Security	(1) Multiple user access levels with password (2) IP address filtering (3) Digest authentication		
Remote Access	(1) Internet Explorer on Windows operating system (2) 16CH Video Viewer on Windows & MAC operating system (3) EagleEyes on iPhone, iPad & Android mobile devices		
■ Video			
Video Compression	H.264 (Main Profile) / MJPEG		
Resolution	1080P to CIF		
Frame Rate	30fps		
Multiple Video Streaming	4 (H.264, MJPEG)		
■ General			
Image Sensor	1/2.9" SONY CMOS image sensor	1/2.8" SONY CMOS image sensor	
Min Illumination	1 Lux / F2.0, 0 Lux (LED ON)	0.1 Lux / F2.0 (wide)~F2.8(Tele), 0 Lux (LED ON)	
S/N Ratio	More than 48dB (AGC off)		
Electronic Shutter	1/7.5 to 1/8000 sec	1/10,000 ~ 1/7.5 (Slow shutter)	
Lens	f6.0 ~ 60mm / F2.0 ~ 2.8 10X Optical Zoom, Auto Focus, Near focus limit 10cm (wide) or 80cm (tele) to infinity		
Viewing Angle	1X: 47.3° (Horizontal) x 27.5° (Vertical) x 53.5° (Diagonal) 10X: 5.3° (Horizontal) x 3.0° (Vertical) x 6.1° (Diagonal)		
IR LED	YES		
IR Effective Range**	Default mode: up to 40 meters IR enhanced mode: up to 60 meters		
IR Shift	YES		
IRIS Mode	YES (Two stage)	AES	
POE	YES (IEEE 802.3af)		YES (IEEE 802.3at)
WDR	--	YES	
External Alarm I/O	YES (1 input / 1 output)		
Heater	NO		YES
IP Rating	IP67		
White Balance	ATW		
AGC	Auto		
Operating Temperature	-10°C~40°C	-20°C~40°C	-40°C ~ 40°C
Power Source (±10%)	12V / 1A	12V / 1.5A	12V / 2A
Power Consumption	DC Adapter: 9W (Max)		PoE & PoN: 28.5W; DC Adapter: 24W
■ Others			
Mobile Surveillance	iPad / iPhone / Android mobile device		
Event Notification	FTP / Email / SMS		
Digital Pan / Tilt / Zoom	YES		
Motion Detection	YES		
RTC (real-time clock)	YES		
Minimum Web Browsing Requirements	<ul style="list-style-type: none"> • Intel core i3 or higher, or equivalent AMD • 2 GB RAM • AGP graphics card, Direct Draw, 32MB RAM • Windows 7, Vista & XP, DirectX 9.0 or later • Internet Explorer 7.x or later 		

* The specifications are subject to change without notice.

** Dimensional tolerance: ± 5mm

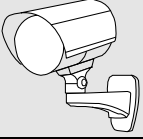
	Model 10	Model 11
■ Network		
LAN Port	YES	
LAN Speed	10/100 Based-T Ethernet	
Supported Protocols	DDNS, PPPoE, DHCP, NTP, SNTP, TCP/IP, ICMP, SMTP, FTP, HTTP, RTP, RTSP, RTCP, IPv4, Bonjour, UPnP, DNS, UDP, IGMP, QoS	
Number of Online Users	10	
ONVIF Compatible	YES (Profile S)	
Security	(1) Multiple user access levels with password (2) IP address filtering (3) Digest authentication	
Remote Access	(1) Internet Explorer on Windows operating system (2) 16CH Video Viewer on Windows & MAC operating system (3) EagleEyes on iPhone, iPad & Android mobile devices	
■ Video		
Video Compression	H.264 / MJPEG	
Resolution	1080P to CIF	
Frame Rate	30fps	
Multiple Video Streaming	4 (H.264, MJPEG)	
■ General		
Image Sensor	1/2.8" CMOS image sensor	
Min Illumination	1/10,000 ~ 1/7.5 (Slow shutter)	
S/N Ratio	More than 48dB (AGC off)	
Electronic Shutter	1/2 to 1/10,000 sec	
Lens	f2.8 ~ 12mm / F1.4 ~ F2.8	
Viewing Angle	Wide: 97.4° (Horizontal) / 58.1° (Vertical) / 111.7° (Diagonal) Tele: 27.1° (Horizontal) / 15.2° (Vertical) / 31.1° (Diagonal)	
IR LED	2 Units	
IR Effective Range**	Default : up to 25 meters IR Enhanced Mode : up to 35 meters	
IR Shift	YES	
Smart Light Control	YES	
IRIS Mode	AES	
White Balance	ATW	
AGC	Auto	
WDR	YES	
Privacy Mask	YES	
POE (Power-over-Ethernet)	YES (IEEE 802.3af)	YES (IEEE 802.3at)
External Alarm I/O	YES (1 input / 1 output)	
MicroSD Card Slot	YES	
Heater	NO	YES
IP Rating	IP66	
Operating Temperature	-20°C ~ 40°C	-40°C ~ 40°C
Power Source (±10%)	12V / 1A	12V / 2A
Power Consumption (±10%)	PoE & PoN: 10.5W; DC Adapter: 8.4W	PoE & PoN: 23.5W; DC Adapter: 20W
■ Others		
Mobile Surveillance	iOS & Android	
Event Notification	FTP / Email / SMS	
Digital Pan / Tilt / Zoom	YES	
Motion Detection	YES	
RTC (real-time clock)	YES	
Minimum Web Browsing Requirements	<ul style="list-style-type: none"> • Intel core i3 or higher, or equivalent AMD • 2GB RAM • AGP graphics card, Direct Draw, 32MB RAM • Windows 7, Vista & XP, DirectX 9.0 or later • Internet Explorer 7.x or later 	

*The specifications are subject to change without notice

**Using IR enhanced mode and slow shutter speed, the distance can be extended even longer.

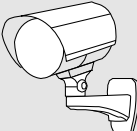
	Model 12	Model 13
■ Network		
LAN Port	YES	
LAN Speed	10/100 Based-T Ethernet	
Supported Protocols	DDNS, PPPoE, DHCP, NTP, SNTP, TCP/IP, ICMP, SMTP, FTP, HTTP, RTP, RTSP, RTCP, IPv4, Bonjour, UPnP, DNS, UDP, IGMP, QoS	
Number of Online Users	10	
ONVIF Compatible	YES (Profile S)	
Security	(1) Multiple user access levels with password (2) IP address filtering (3) Digest authentication	
Remote Access	(1) Internet Explorer on Windows operating system (2) 16CH Video Viewer on Windows & MAC operating system (3) EagleEyes on iPhone, iPad & Android mobile devices	
■ Video		
Video Compression	H.264 / MPEG4 / MJPEG	
Resolution	1080P, SXGA, 720P, VGA, QVGA	
Frame Rate	30fps	
Multiple Video Streaming	4 (H.264, MJPEG, MPEG4)	
■ General		
Image Sensor	1/2.9" CMOS image sensor	
Min Illumination	1 Lux / F1.4, 0 Lux (IR LED ON)	
S/N Ratio	More than 48dB (AGC off)	
Electronic Shutter	1/2 to 1/10,000 sec	
Lens	f2.8 ~ 12mm / F1.4 ~ F2.8	
Viewing Angle	Wide: 109° (Horizontal) / 76° (Vertical) / 116° (Diagonal) Tele: 24° (Horizontal) / 13.5° (Vertical) / 27° (Diagonal)	
IR LED	2 Units	
IR Effective Range**	Default : up to 25 meters IR Enhanced Mode : up to 35 meters	
IR Shift	YES	
Smart Light Control	NO	
IRIS Mode	AES	
White Balance	ATW	
AGC	Auto	
WDR	NO	
POE (Power-over-Ethernet)	YES (IEEE 802.3af)	YES (IEEE 802.3at)
External Alarm I/O	YES (1 input / 1 output)	
MicroSD Card Slot	YES	
Heater	NO	YES
IP Rating	IP66	
Operating Temperature	-20°C ~ 40°C	-40°C ~ 40°C
Power Source (±10%)	12V / 1A	12V / 2A
Power Consumption (±10%)	PoE & PoN: 12.5W; DC Adapter: 10.25W	PoE & PoN: 25W; DC Adapter: 21.1W
■ Others		
Mobile Surveillance	iOS & Android	
Event Notification	FTP / Email / SMS	
Digital Pan / Tilt / Zoom	YES	
Motion Detection	YES	
RTC (real-time clock)	YES	
Minimum Web Browsing Requirements	<ul style="list-style-type: none"> • Intel core i3 or higher, or equivalent AMD • 2GB RAM • AGP graphics card, Direct Draw, 32MB RAM • Windows 7, Vista & XP, DirectX 9.0 or later • Internet Explorer 7.x or later 	

*The specifications are subject to change without notice

**Using IR enhanced mode and slow shutter speed, the distance can be extended even longer.

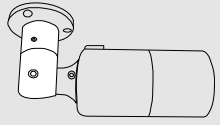

Model 14

■ Network	
LAN Port	YES
LAN Speed	10/100 Based-T Ethernet
Supported Protocols	DDNS, PPPoE, DHCP, NTP, SNTP, TCP/IP, ICMP, SMTP, FTP, HTTP, RTP, RTSP, RTCP, IPv4, Bonjour, UPnP, DNS, UDP, IGMP, QoS
Number of Online Users	10
ONVIF Compatible	YES (Profile S)
Security	(1) Multiple user access levels with password (2) IP address filtering (3) Digest authentication
Remote Access	(1) Internet Explorer on Windows operating system (2) 16CH Video Viewer on Windows & MAC operating system (3) EagleEyes on iPhone, iPad & Android mobile devices
■ Video	
Video Compression	H.264 (Main Profile) / MJPEG
Resolution	1920 x 1080 / 1280 x 720 / 720 x 480 / 352 x 288
Frame Rate	30fps
Multiple Video Streaming	4 (H.264, MJPEG)
■ General	
Image Sensor	1/2.8" SONY CMOS image sensor
Min Illumination	0.1 Lux / F1.4(Wide)~F2.8(Tele), 0 Lux (IR LED ON)
Shutter Speed	1/10,000 ~ 1/7.5 (Slow shutter)
S/N Ratio	More than 48dB (AGC off)
Lens	f2.8 ~ 12mm / F1.4 ~ F2.8
Viewing Angle	Wide: 97.4° (Horizontal) / 58.1° (Vertical) / 111.7° (Diagonal) Tele: 27.1° (Horizontal) / 15.2° (Vertical) / 31.1°(Diagonal)
IR LED	2 units
IR Effective Distance**	Default : up to 25 meters IR Enhanced Mode : up to 35 meters
IR Shift	YES
Smart Light Control	YES
White Balance	ATW
AGC	Auto
IRIS Mode	AES
WDR	YES
Privacy Mask	YES
POE	YES (IEEE 802.3af)
External Alarm I/O	YES (1 input / 1 output)
MicroSD Card Slot	YES (up to 64GB)
IP Rating	IP66
Operating Temperature	-20°C ~ 50°C
Power Source (±10%)	DC12V / 1A
Current Consumption (±10%)	700mA
Power Consumption (±10%)	10.5W (PoE); 10.5W (PoN) ; 8.4W (DC Adapter)
■ Others	
Mobile Surveillance	iOS & Android mobile devices
Event Notification	FTP / Email / SMS
Digital Pan / Tilt / Zoom	YES
Motion Detection	YES
RTC (real-time clock)	YES
Minimum Web Browsing Requirements	<ul style="list-style-type: none"> • Intel core i3 or higher, or equivalent AMD • 2GB RAM • AGP graphics card, Direct Draw, 32MB RAM • Windows 7, Vista & XP, DirectX 9.0 or later • Internet Explorer 7.x or later

*The specifications are subject to change without notice.

**By using IR enhanced mode and slow shutter speed, the distance can be extended even longer.

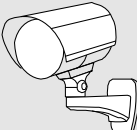
	Model 15	Model 16
■ Network		
LAN Port	YES	
LAN Speed	10/100 Based-T Ethernet	
Supported Protocols	DDNS, PPPoE, DHCP, NTP, SNTP, TCP/IP, ICMP, SMTP, FTP, HTTP, RTP, RTSP, RTCP, IPv4, Bonjour, UPnP, DNS, UDP, IGMP, QoS	
ONVIF Compatible	YES (Profile S)	
Number of Online Users	10	
Security	(1) Multiple user access levels with password (2) IP address filtering (3) Digest authentication	
Remote Access	(1) Internet Explorer on Windows operating system (2) 16CH Video Viewer on Windows & MAC operating system (3) EagleEyes on iPhone, iPad & Android mobile devices	
■ Video		
Network Compression	H.264 / MPEG4 / MJPEG	
Video Resolution	1280 x 1024 / 1280 x 720 / 640 x 480 / 320 x 240	
Frame Rate	30fps	
Multiple Video Streaming	4 (H.264 / MPEG4 / MJPEG)	
■ General		
Image Sensor	1/3" SONY CMOS image sensor	
Min Illumination	1 Lux / F1.5, 0 Lux (IR LED ON)	
Shutter Speed	1/2 to 1/10,000 sec	
S/N Ratio	More than 48dB (AGC off)	
Lens	f3.8mm / F1.5	
Viewing Angle	65.4° (Horizontal) / 49.9° (Vertical) / 80.4° (Diagonal)	
IR LED	2 units	
IR Effective Distance**	Default : up to 25 meters IR Enhanced Mode : up to 35 meters	
IR Shift	YES	
White Balance	ATW	
AGC	Auto	
IRIS Mode	AES	
POE	YES (IEEE 802.3af)	
External Alarm I/O	YES (1 input / 1 output)	
MicroSD Card Slot	YES (up to 64GB)	
Heater	NO	YES
IP Rating	IP66	
Operating Temperature	-20°C ~50°C	-40°C ~50°C
Power Source (±10%)	DC12V / 1A	
Current Consumption (±10%)	627mA max	1.32mA (IR Enhanced Mode ON + Heater ON)
Power Consumption (±10%)	9.74W (PoE) ; 9.74W (PoN) ; 8.28W max (DC Adapter)	20.5W (PoE) ; 20.5W (PoN) ; 17.42W max (DC Adapter)
■ Others		
Mobile Surveillance	iOS & Android mobile devices	
Event Notification	FTP / Email / SMS	
Digital Pan / Tilt / Zoom	YES	
Motion Detection	YES	
RTC (real-time clock)	YES	
Minimum Web Browsing Requirements	<ul style="list-style-type: none"> • Intel core i3 or higher, or equivalent AMD • 2GB RAM • AGP graphics card, Direct Draw, 32MB RAM • Windows 7, Vista & XP, DirectX 9.0 or later • Internet Explorer 7.x or later 	

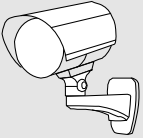
	Model 17	Model 18
■ Network		
LAN Port	YES	
LAN Speed	10/100 Based-T Ethernet	
Supported Protocols	DDNS, PPPoE, DHCP, NTP, SNTP, TCP/IP, ICMP, SMTP, FTP, HTTP, RTP, RTSP, RTCP, IPv4, Bonjour, UPnP, DNS, UDP, IGMP, QoS	
ONVIF Compatible	YES (Profile S)	
Number of Online Users	10	
Security	(1) Multiple user access levels with password (2) IP address filtering (3) Digest authentication	
Remote Access	(1) Internet Explorer on Windows operating system (2) 16CH Video Viewer on Windows & MAC operating system (3) EagleEyes on iPhone, iPad & Android mobile devices	
■ Video		
Network Compression	H.264 / MPEG4 / MJPEG	
Video Resolution	1920 x 1080 / 1280 x 720 / 640 x 480 / 320 x 240	
Frame Rate	30fps	
Multiple Video Streaming	4 (H.264 / MPEG4 / MJPEG)	
■ General		
Image Sensor	1/2.9" SONY CMOS image sensor	
Min Illumination	0.1 Lux / F1.5, 0 Lux (LED ON)	
Shutter Speed	1/2 to 1/10,000 sec	
S/N Ratio	More than 48dB (AGC off)	
Lens	f3.8mm / F1.5	
Viewing Angle	73.2° (Horizontal) / 42.8° (Vertical) / 83.2° (Diagonal)	
IR LED	2 units	
IR Effective Distance**	Default : up to 25 meters IR Enhanced Mode : up to 35 meters	
IR Shift	YES	
White Balance	ATW	
AGC	Auto	
IRIS Mode	AES	
POE	YES (IEEE 802.3af)	
External Alarm I/O	YES (1 input / 1 output)	
MicroSD Card Slot	YES (up to 64GB)	
Heater	NO	YES
IP Rating	IP66	
Operating Temperature	-20°C ~ 50°C	-40°C ~ 50°C
Power Source (±10%)	DC12V / 1A	DC12V / 2A
Current Consumption (±10%)	630mA (LED ON)	1.335A (IR Enhanced Mode ON + Heater ON)
Power Consumption (±10%)	10W (PoE); 10W (PoN) ; 8.5W (DC Adapter)	20.73W Max (PoE); 20.73W (PoN) ; 17.62W max (DC Adapter)
■ Others		
Mobile Surveillance	iOS & Android mobile devices	
Event Notification	FTP / Email / SMS	
Digital Pan / Tilt / Zoom	YES	
Motion Detection	YES	
RTC (real-time clock)	YES	
Minimum Web Browsing Requirements	<ul style="list-style-type: none"> • Intel core i3 or higher, or equivalent AMD • 2GB RAM • AGP graphics card, Direct Draw, 32MB RAM • Windows 7, Vista & XP, DirectX 9.0 or later • Internet Explorer 7.x or later 	

*The specifications are subject to change without notice.

**By using IR enhanced mode and slow shutter speed, the distance can be extended even longer.

APPENDIX 2 BIT RATE TABLE FOR REFERENCE

The data below is for reference only.

The bit rates listed here may vary depending on the resolution, image quality & frame rate you choose, the complexity of your monitoring area, and how often the moving objects show in your monitoring area.

Testing Environment

- Place: Office Entrance
- Network translation: H.264
- Camera type: Megapixel camera

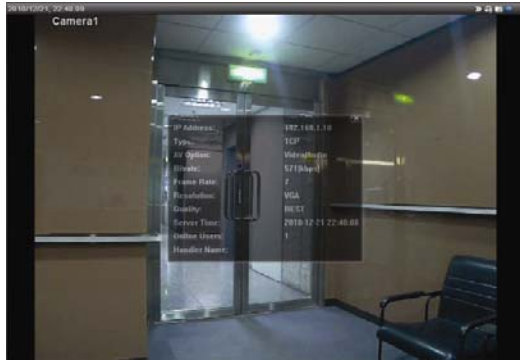

Static: No one coming in and out



Dynamic: One or two people coming in and out

Resolution	Quality	Frame Rate	(Dynamic) kbps	(Static) kbps
SXGA	Best	FULL	3253	3216
	High		2375	2160
	Normal		1571	1266
	Basic		1465	873
VGA	Best		2010	1261
	High		1042	1034
	Normal		685	572
	Basic		457	350
QVGA	Best		646	366
	High		482	350
	Normal		302	286
	Basic		168	161
SXGA	Best	1/4	1163	1076
	High		989	715
	Normal		855	534
	Basic		719	443
VGA	Best		789	571
	High		451	447
	Normal		349	237
	Basic		217	165
QVGA	Best		269	147
	High		182	131
	Normal		164	113
	Basic		97	71

Resolution	Quality	Frame Rate	(Dynamic) kbps	(Static) kbps
SXGA	Best	1/15	581	374
	High		405	342
	Normal		487	248
	Basic		337	141
VGA	Best		358	79
	High		201	63
	Normal		180	28
	Basic		92	15
QVGA	Best		111	84
	High		99	68
	Normal		97	54
	Basic		58	42

APPENDIX 3 POE CONNECTION

This device supports PoE (Power-over-Ethernet), developed by the IEEE802.3af or IEEE802.3at task force, and power can be supplied over the same network (Ethernet) cable as the one used to connect to Internet. No power cable is needed. Below shows two examples of POE application for reference.

- When your router / hub supports POE connection

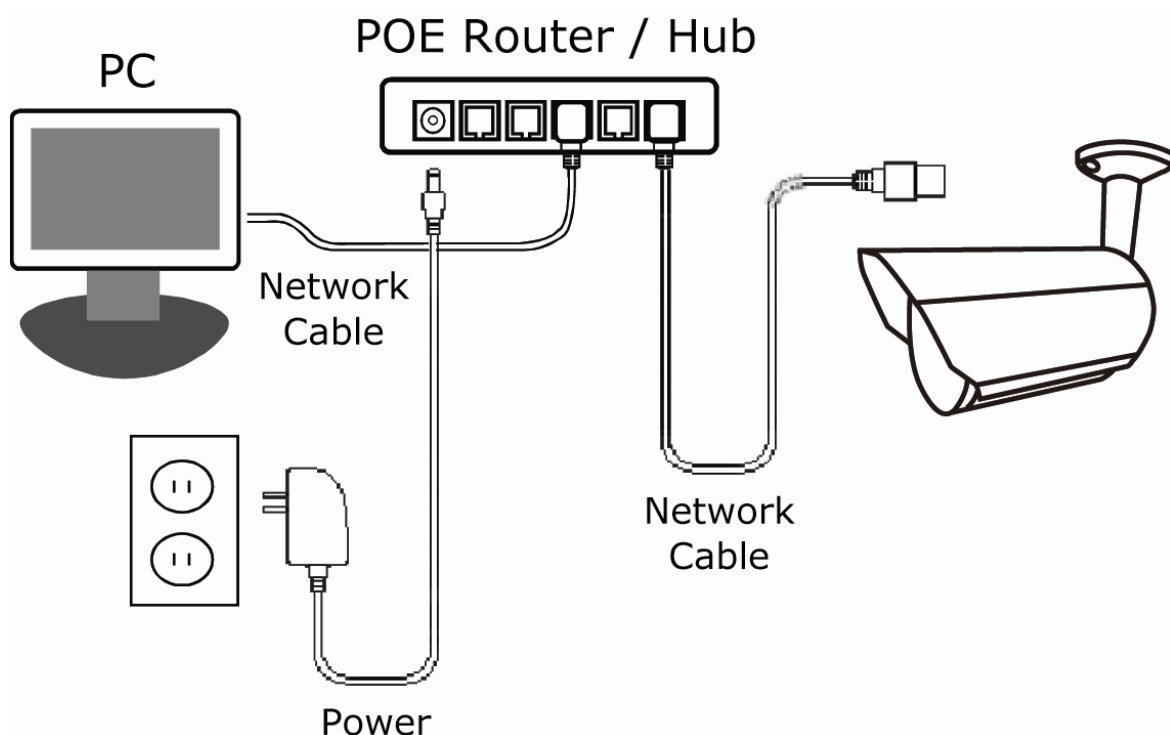

- When your router / hub doesn't support POE connection (An optional POE connector required)

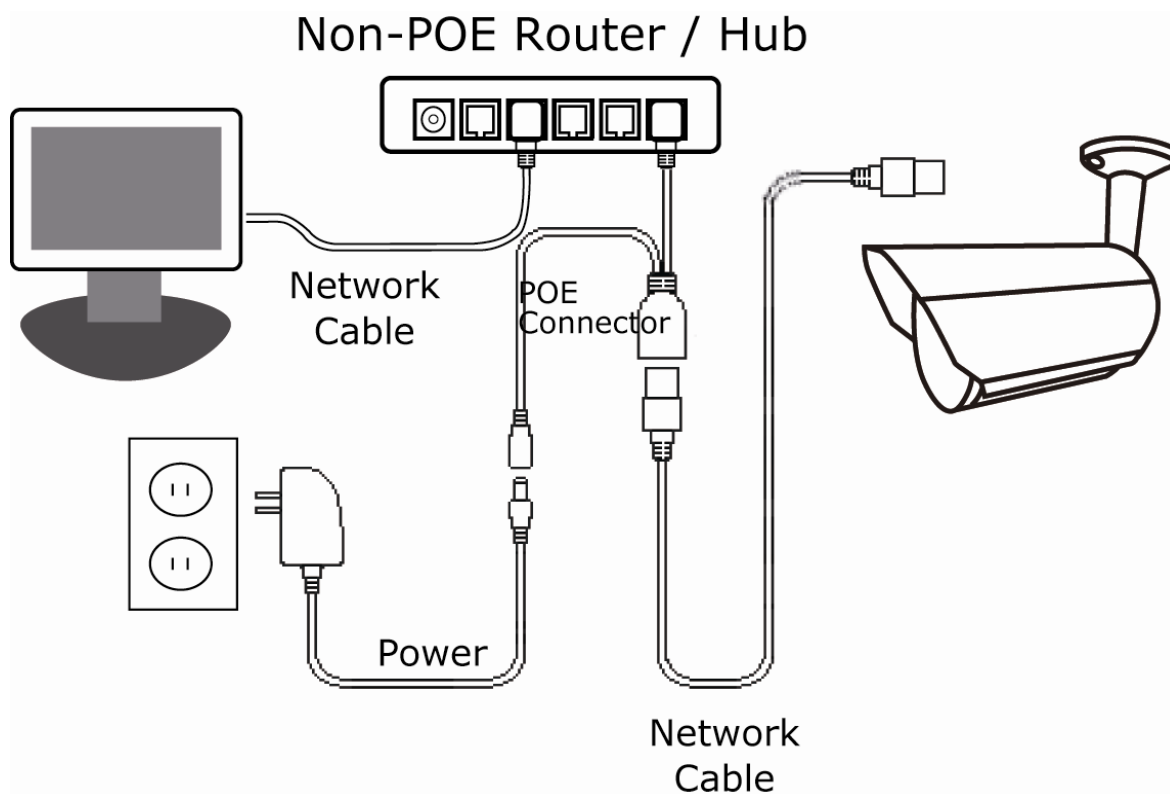

APPENDIX 4 API ID APPLICATION FOR SMS MESSAGING

To allow the camera automatically sending a text message when an event happens, you need to apply an API ID from a mobile messaging company first, such as Clickatell or EVERY8D.

Below shows an example of how to get an API ID from Clickatell.

Note: The SMS messaging may not be totally free. Please check the charge policy of the messaging service you use.

Note: The instructions below are for reference only and may vary when Clickatell's official website is updated.

Please follow the steps below for application.

Step1: Go to <http://www.clickatell.com/login.php>. Sign up an account first.

Login **Click to create an account.**

Which product would you like to log in to? Don't have an account? Sign up here

- Communicator2**
Send bulk SMS via the internet. No programming needed.
- Developers Central**
Reliable, scalable, customisable. Integrates with your system via APIs.
- Messenger Pro**
Desktop, Bulk SMS solution.
- ICM**
Campaign management for standard and premium-rate marketing campaigns.
- Affiliates**
Advertise Clickatell and increase your earnings with our affiliate program.

Step2: Select “Developers Central”, select the location where you want to use this service, and fill in your information to create an account.

Which product would you like to sign up for?

- Communicator2
- Developers Central** ← **Developers Central**

Which product is right for me? How much will it cost?

Where would you like to send messages to? **Check which one is suitable for you.**

- International** (Free signup) ← **International**
- South Africa (Free signup)
- UK (Free signup)
- Ireland (Free signup)
- India (Free signup)

What is your first name? *

test ✓

What is your last name? *

test ✓

Which username would you like to use? *

test ✓

What is your mobile number? *

886 22586666 ✓

[Country code][area code or network code (without first 0) and mobile number, no space, brackets or dashes] Example: [1][4155551212](for USA) or [27][123457894](for South Africa)

What is your email address? * [Privacy Policy](#)

test@tech.com ✓

Are you human? *Please enter the words you see in the box, in order and separated by a space.

dymovant This

Type the two words: dymovant This

noCAPTCHA reCAPTCHA v3

Create your account

Create my Account By clicking this button, you agree to Clickatell's [Terms and Conditions](#)

Step3: When the account is created, the system will automatically send an Email to your specified Email address with the user name, password, and client ID used to log into the service.

Step4: Click the link within the email to log in, and you will be prompted to validate your mobile phone number. Select “SEND ACTIVATION CODE”. The system will send an activation code to that number for verification.

Check if you receive a text message from Clickatell, and enter the activation code.

Verify your Mobile Number

For security reasons you are required to verify your mobile number in order to make your first credit purchase and send non-test SMS messages.

Your activation code will be sent to

If this is not your number, please retype your mobile number in the box above and click the "SEND ACTIVATION CODE NOW"

Enter your activation code once you have received it on your mobile phone:

Coupon Code:

Enter activation code here

Step4: In your account, find "Connection Status" and create a connection (API ID).

Note: Information on this page may be delayed by up to 1 minute.

<p>Account Status</p> <p>Credit Balance: 0</p> <p>Payments Pending: 0</p> <p>Credit Balance Alert: Disabled</p> <p>Auto Billing: Disabled</p> <p>SMS Bundle: Disabled</p> <p>SenderID: OK</p> <p>View Daily Volumes</p>	<p>Message Delivery Status MT</p> <p>For period 15 April 2013 between 00:00 and 23:59 (GMT+2)</p> <p>Messages delivered: 0</p> <p>Messages failed: 0</p> <p>Total: 0</p> <p>Click here to view a detailed report.</p>
<p>Connection Status</p> <p>Click here to create a connection (API ID)</p> <p>Click here</p>	<p>Message Delivery Status MO</p> <p>For period 15 April 2013 between 00:00 and 23:59 (GMT+2)</p> <p>MO received: 0</p> <p>Click here to view a detailed report.</p>

Step5: Select "HTTP/S".

Connection Setup

Choose the connection that you would like to add to your account.

HTTP/S **Click "HTTP/S"**

Our most popular connection, HTTP is one of the simpler ways to connect to the Clickatell API. It is used as an HTTP/Internet Post.

SMTP (Email to SMS)

Another firm favourite, the SMTP API allows messages that are sent via e-mail to be converted to SMS. Popular with customers who already have an e-mail messaging system in place.

Give a meaning name for this connection, and click "Submit and Get API ID".

Add Connection

HTTP API - Information entered during this step can be modified later.

Description: **Give a name for this connection**

Required field

Replace Leading Zero (Dial Prefix)

Enable IP Address Restriction (IP Lock Down)

Enable SMS Status Notification (MT Callback)

Click

Step5: An API ID will be generated as follows.

Note: Note down the API ID for SMS notification setting later.

HTTP API

Your HTTP API connection was created successfully. Your connection is live ready for you to send SMS messages.

API ID used for SMS

API ID:

Description:

APPENDIX 5 Q&A

For more details about Q&A, please visit our official website: www.eagleeyesctv.com

Question	Answer
<p>I can connect to this camera in my house or office where it's installed with wireless network.</p> <p>But when I leave my house or office, I can't connect to it from my mobile phone (with 3G network), or other PC (connected to Internet). Why?</p>	<p>You didn't configure this camera to Internet, but only in LAN.</p> <p>Please follow the steps in the advanced network setup guide downloadable from www.surveillance-download.com/user/m359a.swf to complete network configurations, or it's recommended for you to check with your local installer or reseller for this service because it's usually hard for a person who doesn't have network knowledge to set network configurations.</p>
<p>My live images are not fluent. Why?</p>	<p>Image fluency could be affected by the local network upload bandwidth, router efficiency, client network download bandwidth, complexity of live view, and more.</p> <p>(Recommended) To have the best image fluency, select QVGA; to have the best image quality, select "SXVGA" based on the model you have; to have normal image fluency and quality, select "VGA".</p>
<p>The live video keeps flickering. Why?</p>	<p>Please try adjusting the power line frequency to "60 Hz" or "50 Hz" for the camera.</p> <p>For iPhone users, access the camera, and select "" on the top right corner to enter IPCAM Configuration page. Then, go to "Advance Setup" → "Camera" to change setting.</p> <p>For access from Internet Explorer, log into the camera, and select "Config." → "Camera" → "Camera".</p>

APPENDIX 6 RECORDING TIME TABLE

Below shows the estimated total recording time for each recording resolution.

The recording time per resolution is the average value collected from the both alarm trigger conditions indicated in “Testing Environment”, and is for reference only.

The time may vary depending on the resolution, image quality & frame rate you choose, the complexity of your monitoring area, and how often the moving objects show in your monitoring area.

Testing Environment

- Place: Office
- Monitoring area: 1.5 meters away from the camera
- Alarm trigger conditions:
 - (1) One person walks by the monitoring area and leaves immediately.
 - (2) Two persons walk by the monitoring area. One goes away immediately, and the other one stays a while and goes away.

Recording Resolution	SXGA	VGA	QVGA
Recording time (second)	25	115	211

APPENDIX 7 MICRO SD CARD COMPATIBLE LIST

Manufacturer	Capacity	Class	Manufacturer	Capacity	Class
ADATA	2GB	--	Transcend	2GB	--
	4GB	Class 6		4GB	Class 2
Apacer	2GB	--		4GB	Class 4
	4GB	Class 4		4GB	Class 6
SanDisk	2GB	--		8GB	Class 6
	4GB	Class 4	16GB	Class 10	
	8GB	Class 4	Kingston	2GB	--
	16GB	Class 4		4GB	Class 4
	32GB	Class 4		8GB	Class 4
Verico	2GB	--		32GB	Class 4
	4GB	Class 4		64GB	Class 10
	16GB	Class 10	TOSHIBA	16GB	Class 4
Silicon Power	64GB	--	TOPRAM	32GB	Class 10
Kingmax	64GB	--			